

トリニトロン®カラービデオモニター/Trinitron® Color Video Monitor

PVM-5041Q/6041Q

PVM-6041QM

取扱説明書

お買い上げいただき、ありがとうございます。



電気製品は安全のための注意事項を守らないと、火災や人身事故になることがあります。

この取扱説明書には、事故を防ぐための重要な注意事項と製品の取り扱いかたを示しています。この取扱説明書と別冊の「安全のために」をよくお読みのうえ、製品を安全にお使いください。お読みになったあとは、いつでも見られるところに必ず保管してください。

Operating Instructions

Before operating the unit, please read this manual thoroughly and retain it for future reference.

Mode d'emploi

Avant la mise en service de cet appareil, prière de lire attentivement ce mode d'emploi et de le conserver pour toute référence ultérieure.

Bedienungsanleitung

Vor Inbetriebnahme des Geräts lesen Sie bitte diese Anleitung aufmerksam durch und bewahren Sie sie zum späteren Nachschlagen gut auf.

Manual de instrucciones

Antes de emplear la unidad, lea detenidamente este manual de instrucciones, y consérvelo para futuras referencias.

Istruzioni per l'uso

Prima di usare l'apparecchio, leggere con attenzione questo manuale e conservarlo per riferimenti futuri.

Owner's Record

The model and serial numbers are located on the rear.

Record the model and serial numbers in the spaces provided below. Refer to these numbers whenever you call upon your Sony dealer regarding this product.

Model No. _____ Serial No. _____

日本語

English

Français

Deutsch

Español

Italiano

WARNING

To prevent fire or shock hazard, do not expose the unit to rain or moisture.

Dangerously high voltages are present inside the unit. Do not open the cabinet. Refer servicing to qualified personnel only.

This symbol is intended to alert the user to the presence of uninsulated “dangerous voltage” within the product’s enclosure that may be of sufficient magnitude to constitute a risk of electric shock to persons.

This symbol is intended to alert the user to the presence of important operating and maintenance (servicing) instructions in the literature accompanying the appliance.

For the Customers in the USA

This equipment has been tested and found to comply with the limits for a Class A digital device, pursuant to Part 15 of the FCC Rules. These limits are designed to provide reasonable protection against harmful interference when the equipment is operated in a commercial environment. This equipment generates, uses, and can radiate radio frequency energy and, if not installed and used in accordance with the instruction manual, may cause harmful interference to radio communications. Operation of this equipment in a residential area is likely to cause harmful interference in which case the user will be required to correct the interference at his own expense.

You are cautioned that any changes or modifications not expressly approved in this manual could void your authority to operate this equipment.

For the customers in Europe (PVM-6041QM)

This product with the CE marking complies with both the EMC Directive (89/336/EEC) and the Low Voltage Directive (73/23/EEC) issued by the Commission of the European Community.

Compliance with these directives implies conformity to the following European standards:

- EN60950: Product Safety
- EN55103-1: Electromagnetic Interference (Emission)
- EN55103-2: Electromagnetic Susceptibility (Immunity)

This product is intended for use in the following

Electromagnetic Environment(s):

E1 (residential), E2 (commercial and light industrial), E3 (urban outdoors) and E4 (controlled EMC environment, ex. TV studio).

Important Safety Instruction

- 1) Read these instructions.
- 2) Keep these instructions.
- 3) Heed all warnings.
- 4) Follow all instructions.
- 5) Do not use this apparatus near water.
- 6) Clean only with dry cloth.
- 7) Do not block any ventilation openings. Install in accordance with the manufacturer’s instructions.
- 8) Do not install near any heat sources such as radiators, heat registers, stoves, or other apparatus (including amplifiers) that produce heat.
- 9) Do not defeat the safety purpose of the polarized or grounding-type plug. A polarized plug has two blades with one wider than the other. A grounding type plug has two blades and a third grounding prong. The wide blade or the third prong are provided for your safety. If the provided plug does not fit into your outlet, consult an electrician for replacement of the obsolete outlet.
- 10) Protect the power cord from being walked on or pinched particularly at plugs, convenience receptacles, and the point where they exit from the apparatus.
- 11) Only use attachments/accessories specified by the manufacturer.
- 12) Use only with the cart, stand, tripod, bracket, or table specified by the manufacturer, or sold with the apparatus. When a cart is used, use caution when moving the cart/apparatus combination to avoid injury from tip-over.



- 13) Unplug this apparatus during lightning storms or when unused for long periods of time.
- 14) Refer all servicing to qualified service personnel. Servicing is required when the apparatus has been damaged in any way, such as power-supply cord or plug is damaged, liquid has been spilled or objects have fallen into the apparatus, the apparatus has been exposed to rain or moisture, does not operate normally, or has been dropped.

Table of Contents

Features	1
Location and function of parts and controls	2
Power sources	4
Specifications	5

This instruction manual covers PVM-5041Q and PVM-6041QM.

Features

Four color systems available

The monitor can display NTSC^{3.58}, PAL, SECAM and NTSC^{4.43}¹⁾ signals. The appropriate color system is selected automatically.

Blue only picture

The picture can be displayed in blue and black only. This facilitates hue adjustment and the observation of video noise.

Analog RGB/component input connectors

Analog RGB or component (Y, R-Y, and B-Y) signals from video equipment can be input through these connectors.

Beam current feedback circuit

The built-in beam current feedback circuit assures stable white balance.

Comb filter

When NTSC video signals are received, a comb filter activates to increase the resolution, resulting in fine picture detail without color spill or color noise.

Under scan 4:3/16:9 selector²⁾

The monitor can display the 16:9 signal with the correct ratio of width and height, compressing the picture vertically. Selecting 16:9 with the UNDER SCAN 4:3/16:9 selector on the rear panel in the under scan mode, the ratio of the picture will change to 16:9.

Automatic termination

(only connector marked \sim)

The VIDEO IN connector is terminated at 75 ohms inside, when no cable is connected to the loop-through output connectors. When a cable is connected to an output connector, the 75-ohm termination is automatically released.

EIA standard 19-inch rack mounting

By using an MB-520 mounting bracket (not supplied), the monitor can be mounted in an EIA standard 19-inch rack. For details on mounting, see the instruction manual of the MB-520.

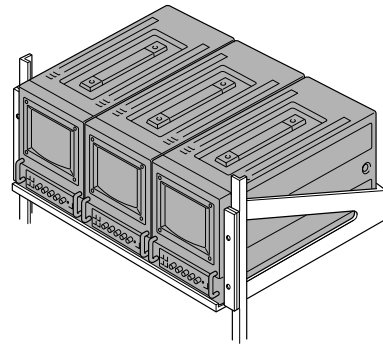

- 1) An NTSC^{4.43} signal is used for playing back NTSC-recorded video cassettes with a video tape recorder/player especially designed for use with this system.
- 2) The UNDER SCAN 4:3/16:9 selector has been adopted since the serial No. 2500001 product.

Precautions

On safety

- Operate the unit on 100 – 240 V AC (for PVM-6041QM), 120 V AC (for PVM-5041Q) or 12 V DC. For the AC operation, use only the supplied AC power cord or the AC power adaptor recommended (not supplied). Do not use any other type. For the battery operation, use only the NP-1A/1B battery pack (not supplied). Do not use any other batteries.
- Should any liquid or solid object fall into the cabinet, unplug the unit and have it checked by qualified personnel before operating it further.
- Unplug the unit from the wall outlet if it is not to be used for several days.
- To disconnect the AC power cord, pull it out by the plug. Never pull the cord itself.

On installation

- Allow adequate air circulation to prevent internal heat build-up. Do not place the unit on surfaces (rugs, blankets, etc.) or near materials (curtains, draperies) that may block the ventilation holes.
- Do not install the unit near heat sources such as radiators or air ducts, or in a place subject to direct sunlight, excessive dust, mechanical vibration or shock.

- Keep the unit away from a loudspeaker or motor, as the picture may be affected.
- If you mount the monitor in a rack or shelf, devices around the monitor may prevent adequate air circulation, raising the operating temperature and possibly causing malfunction or overheating. Take care to leave adequate clearance around the monitor and not to block the ventilation holes. Or install a ventilation fan to keep the operating temperature range between 0°C and 35°C.

On cleaning

Clean the unit with a slightly dampened soft cloth. Use a mild household detergent. Never use strong solvents such as thinner or benzene as they might damage the finish of the cabinet.

As a safety precaution, unplug the unit before cleaning it.

On repacking

Retain the original carton and packing materials for safe transport of this unit in the future.

If you have any questions about this unit, contact your authorized Sony dealer.

Location and Function of Parts and Controls

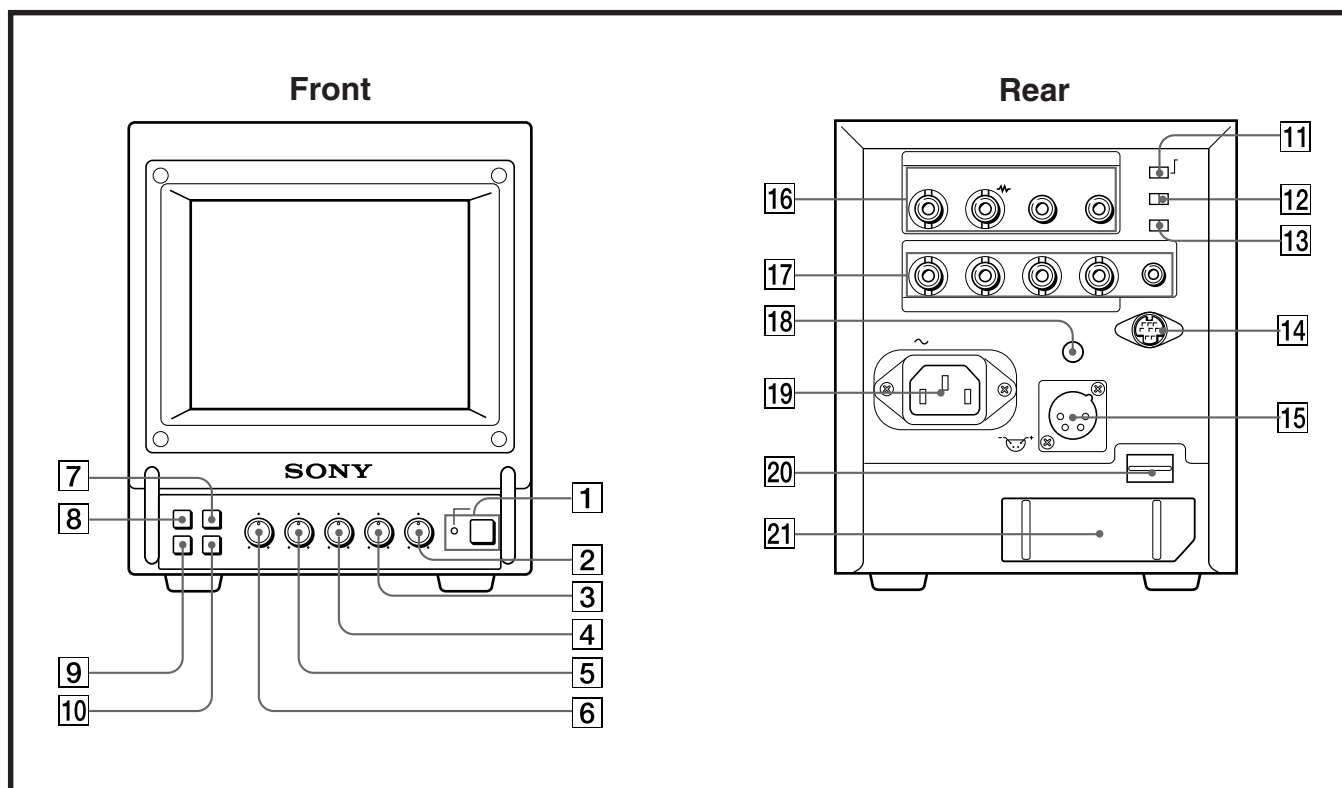

1 POWER switch and indicator

Depress to turn the monitor on. The indicator will light up in green.

The POWER indicator also functions as the battery indicator. When the internal battery becomes weak or the power supplied through the DC12V IN jack decreases, the indicator flashes.

2 VOLUME control

Turn this control clockwise or counterclockwise to obtain the desired volume.

3 CONTR (contrast) control

Turn clockwise to make the contrast stronger and counterclockwise to make it weaker.

4 PHASE control

Turn clockwise to make the skin tones greenish and counterclockwise to make them purplish.

5 CHROMA control

Turn clockwise to make the color intensity stronger and counterclockwise to make it weaker.

Note

- The PHASE and CHROMA control settings have no effect on an analog RGB signal.
- The PHASE control has no effect on component signals.
- The PHASE control setting is effective only for the NTSC system.

6 BRIGHT (brightness) control

Turn clockwise for more brightness and counterclockwise for less.

7 H/V DELAY selector

Depress this button to observe the horizontal and vertical sync signals at the same time. The horizontal sync signal is displayed in the left quarter of the screen; the vertical sync signal is displayed near the center of the screen.

8 LINE/RGB input selector

Select the program to be monitored. Keep this button released (LINE) for a signal fed through the LINE connectors. Depress this button (RGB) for a signal fed through the RGB/COMPONENT connectors.

9 BLUE ONLY selector

Depress this button to turn off the red and green signals. A blue signal is displayed as an apparent monochrome picture on the screen. This facilitates "chroma" and "phase" control adjustments and the observation of video noise.

10 UNDER SCAN selector

Depress this button for underscanning. The display size is reduced by approximately 3% so that four corners of the raster are visible.

With this button depressed, if the UNDER SCAN 4:3/16:9 selector on the rear panel is set to 16:9, the ratio of the picture changes to 16:9.

- 11 SYNC INT/EXT (sync internal/external) selector**
Select the internal or external sync.
- 12 RGB/COMP (RGB/component) selector**
Select the RGB or component (Y, R-Y and B-Y) signal. Keep the LINE/RGB input selector on the front panel depressed (RGB), otherwise the RGB/COMP selector does not function.
- 13 UNDER SCAN 4:3/16:9 selector**
Set to compress the picture vertically to monitor the 16:9 input signal with the correct ratio. The function of the UNDER SCAN button on the front panel is changed by the position of this selector.

UNDER SCAN button 4:3/16:9 selector	Not depressed (□)	Depressed (▣)
When the selector is set to 4:3	The 4:3 input signal is monitored with normal scanning.	The 4:3 input signal is monitored with underscanning.
When the selector is set to 16:9	The 4:3 input signal is monitored with normal scanning.	The 16:9 input signal is monitored with underscanning. (Compressed vertically)

The UNDER SCAN 4:3/16:9 selector has been adopted since the serial No. 2500001 product.

- 14 REMOTE connector (8-pin mini DIN)**
Connect to a remote controller. For the pin assignment of this connector, see "Specifications" on page 5.
- 15 DC 12V IN jack (XLR, 4 pin)**
Connect the Sony AC-500/500CE AC power adaptor (not supplied).

- 16 LINE connectors**
To monitor the signal fed through these connectors, keep the LINE/RGB selector on the front panel released (LINE).
VIDEO IN (BNC): Connect to the video output connector of a video camera, VCR or other video equipment.
VIDEO OUT (BNC): Loop-through output of the VIDEO IN connector. Connect to the video input connector of a VCR or another monitor.
AUDIO IN (phono jack): Connect to the audio output connector of a VCR or a microphone (through a suitable microphone amplifier).
AUDIO OUT (phono jack): Loop-through output of the AUDIO IN connector. Connect to the audio input connector of a VCR or another monitor.

- 17 RGB/COMPONENT input connectors R/R-Y, G/Y, B/B-Y, (BNC), AUDIO (phono):**
To monitor a signal fed through these connectors, depress the LINE/RGB selector on the front panel (RGB).

To monitor the analog RGB signal

Connect to the analog RGB signal outputs connector of a video camera. Set the RGB/COMP selector to RGB.

To monitor the component signal

Connect to the R-Y/Y-B-Y component signal outputs connector of a Sony Betacam video camera. Set the RGB/COMP selector to COMP (component).

SYNC (BNC):

To operate the monitor on an external sync, connect the reference signal from a sync generator. Set the SYNC INT/EXT selector to EXT (external).

- 18 V HOLD (vertical hold) control**
Turn to stabilize the picture if it rolls vertically.

- 19 AC IN socket**
Connect the supplied AC power cord to this socket and to a wall outlet.

- 20 EJECT button**
Press the EJECT button upwards to remove the battery pack.

- 21 BATTERY compartment**
Insert the NP-1A/1B battery pack (not supplied).

Power Sources

House Current

Connect the supplied AC power cord to the AC IN socket and to a wall outlet.

When the AC power cord is plugged into the AC IN socket, the battery pack (if installed) or the AC power adaptor (if connected) is automatically disconnected.

To connect an AC power cord securely with AC plug holders

1	2	3
----------	----------	----------

- 1** Remove the AC IN socket screws and then use them to attach AC plug holder A (supplied) to the AC IN socket.
- 2** Plug the power cord to the AC IN socket. Then, attach the supplied AC plug holder B on top of the AC power cord.
- 3** Slide AC plug holder B over the cord until it connects with AC plug holder A.

To remove the AC power cord

Pull out AC power holder B by squeezing the left and right sides.

Rechargeable Battery

To remove the battery pack, press the EJECT button upwards.

For charging, use the BC-1WA battery charger (not supplied) for the NP-1A or the BC-1WB for the NP-1B.

Note

Make sure that the AC power cord and the AC power adaptor are disconnected from the monitor. Otherwise, the monitor cannot operate on the battery pack.

Specifications

Video signal

Color system	NTSC _{3.58} , PAL, SECAM, NTSC _{4.43}
Resolution	250 TV lines
Frequency response	6.0 MHz (−3.0 dB) at all inputs
Synchronization	AFC time constant 1.0 msec.

Picture performance

Normal scan	6% over scan of CRT effective screen area
Underscan	3% underscan of CRT effective screen area
H. linearity	Less than 7.0% (typical)
V. linearity	Less than 7.0% (typical)
Convergence	Central area: 0.50 mm (typical) Peripheral area: 0.60 mm (typical)
Raster size stability	H: 1.0%, V: 1.5%
High voltage regulation	3.0%
Color temperature	D65 (PVM-5041Q/6041QM) D93 (PVM-6041Q)

Inputs and Outputs

Inputs	<p>VIDEO IN: BNC connector 1 Vp-p ±6 dB, sync negative</p> <p>AUDIO IN: phono jack, −5 dBs, less than 47 kohms</p> <p>R/R-Y, G/Y, B/B-Y: BNC connector R, G, B channels: 0.7 Vp-p, ±6 dB Sync on green: 0.3 Vp-p, negative, 75 ohms terminated</p> <p>R-Y, Y, B-Y channels: PVM-5041Q: 0.7 Vp-p, ±6 dB (standard color bar signal of 75% chrominance) PVM-6041QM: 0.7 Vp-p, ±6 dB (standard color bar signal of 100% chrominance)</p> <p>EXT SYNC IN: BNC connector Composite sync 4 Vp-p, ±6 dB, negative</p>
Loop-through outputs	<p>VIDEO OUT: BNC connector, 75 ohms terminated</p> <p>AUDIO OUT: phono jack</p>
Remote input	REMOTE: 8-pin mini DIN connector (See the pin assignment on the right side of this page)
Audio Output level	0.5 W

General

Power consumption	<p>PVM-5041Q: 42 W max at AC operation 40 W at DC operation</p> <p>PVM-6041QM: 40 W at AC operation 40 W at DC operation</p>
Power requirements	<p>PVM-5041Q: 120 V AC, 50/60 Hz</p> <p>PVM-6041QM: 100 – 240 V AC, 50/60 Hz 12 V DC, with the Sony (NP-1A/1B) battery pack (not supplied) or AC-500/500CE AC power adaptor (not supplied)</p>
Peak inrush current (PVM-6041QM)	Hot switching inrush current, measured in accordance with European standard EN55103-1: 58A (230V)
Operating temperature range	0 – 35°C
Storage temperature range	−10 – +40°C
Humidity	0 – 90%
Dimensions	Approx. 146 × 173 × 352.5 mm (w/h/d) (5 ³ / ₄ × 6 ⁷ / ₈ × 14 inches) not incl. projecting parts and controls
Weight	Approx. 5.5 kg (12 lb 2 oz) not incl. battery packs
Accessory supplied	AC power cord (1) Cable with an 8-pin connector AC Plug holders (1 set)

Pin Assignment

REMOTE connector (8-pin mini DIN)

Pin No.	Signal
1	Blue only
2	H/V delay
3	GND
4	INT/EXT SYNC
5	–
6	Underscan/normal scan
7	RGB/Y, R-Y, B-Y
8	RGB/LINE

For remote control, connect the pin of the desired function to pin 3 (GND).

Design and specifications are subject to change without notice.

お問い合わせは
「ソニー業務用製品ご相談窓口のご案内」にある窓口へ

ソニー株式会社 〒141-0001 東京都品川区北品川6-7-35
ソニーマーケティング株式会社 情報システム営業本部 〒108-0074 東京都港区高輪4-10-18

PVM-6041QM

SERVICE MANUAL

AEP Model
Chassis No. SCC-F09D-A

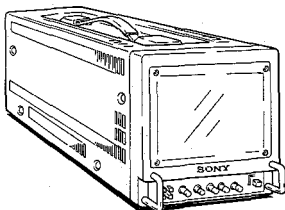

Video signal

Color system	PAL, SECAM, NTSC _{3.58} , NTSC _{4.43}
Resolution	250 TV lines
Frequency response	6.0 MHz (-3.0 dB) at all inputs
Synchronization	AFC time constant 1.0 msec.

Picture performance

Normal scan	6% over scan of CRT effective screen area
Underscan	3% underscan of CRT effective screen area
H. linearity	Less than 7.0% (typical)
V. linearity	Less than 7.0% (typical)
Convergence	Central area: 0.50 mm (typical) Peripheral area: 0.60 mm (typical)
Raster size stability	H: 1.0%, V: 1.5%
High voltage regulation	3.0%
Color temperature	D65

Inputs and Outputs

Inputs	VIDEO IN: BNC connector 1 Vp-p ± 6 dB, sync negative AUDIO IN: phono jack, -5 dBs, less than 47 kohms R/R-Y, G/Y, B/B-Y: BNC connector R, G, B channels: 0.7 Vp-p, ± 6 dB Sync on green: 0.3 Vp-p, negative, 75 ohms terminated R-Y, Y, B-Y channels: 0.7 Vp-p, ± 6 dB (standard color bar signal of 100% chrominance)
--------	--

SPECIFICATIONS

	EXT SYNC IN: BNC connector Composite sync 4 Vp-p, ± 6 dB, negative
Loop-through outputs	VIDEO OUT: BNC connector, 75 ohms terminated AUDIO OUT: phono jack REMOTE: 8-pin mini DIN connector (See the pin assignment on the right side of this page)
Remote input	
Audio Output level	0.5 W

General

Power consumption	40 W at AC operation 40 W at DC operation
Power requirements	100 - 240 V AC, 50/60 Hz 12 V DC, with the Sony (NP-1A/1B) battery pack (not supplied) or AC-500/500CE AC power adaptor (not supplied)
Operating temperature range	0 - 35°C
Storage temperature range	-10 - +40°C
Humidity	0 - 90%

- Continued on next page -



TRINITRON® COLOR VIDEO MONITOR
SONY®

PVM-6041QM

Dimensions	Approx. 146 × 173 × 352.5 mm (w/h/d) (5 ³ / ₄ × 6 ⁷ / ₈ × 14 inches) not incl. projecting parts and controls
Weight	Approx. 5.5 kg (12 lb 2 oz) not incl. battery packs
Accessory supplied	AC power cord (1) Cable with an 8-pin connector AC Plug holders (1 set)

Pin Assignment

REMOTE connector (8-pin mini DIN)



Pin No.	Signal
1	Blue only
2	H/V delay
3	GND
4	INT/EXT SYNC
5	-
6	Underscan/normal scan
7	RGB/Y R-Y B-Y
8	RGB/LINE

For remote control, connect the pin of the desired function to pin 3 (GND).

Design and specifications are subject to change without notice.

TABLE OF CONTENTS

<u>Section</u>	<u>Title</u>	<u>Page</u>	<u>Section</u>	<u>Title</u>	<u>Page</u>
1. GENERAL			4. SAFETY RELATED ADJUSTMENTS		
1-1.	Features	4	4-1.	Safety Related Adjustments	18
1-2.	Location and Function of Parts and Controls	5	5. CIRCUIT ADJUSTMENTS		
1-3.	Power Sources	7	5-1.	D Board Adjustments	20
2. DISASSEMBLY			5-2.	B Board Adjustments	23
2-1.	Cabinet Removal	8	5-3.	S Board Adjustments	28
2-2.	B Board Removal	8	6. DIAGRAMS		
2-3.	Switching Regulator Removal	9	6-1.	Frame Schematic Diagram	29
2-4.	D Board Removal	9	6-2.	Block Diagram (1)	32
2-5.	P Board Removal	10	6-3.	Block Diagram (2)	35
2-6.	Rear Assy Removal	10	6-4.	Circuit Boards Location	40
2-7.	HB and FC Boards Removal	11	6-5.	Printed Wiring Boards and Schematic Diagrams	40
2-8.	Picture Tube Removal	12	6-6.	Semiconductors	74
3. SET-UP ADJUSTMENTS			7. EXPLODED VIEWS		
3-1.	Beam Landing	13	7-1.	Chassis	76
3-2.	Convergence	14	7-2.	Picture Tube	77
3-3.	Focus	16	8. ELECTRICAL PARTS LIST		78
3-4.	White Balance	16			

(CAUTION)

SHORT CIRCUIT THE ANODE OF THE PICTURE TUBE AND THE ANODE CAP TO THE METAL CHASSIS, CRT SHIELD, OR CARBON PAINTED ON THE CRT, AFTER REMOVING THE ANODE.

WARNING!!

AN ISOLATION TRANSFORMER SHOULD BE USED DURING ANY SERVICE TO AVOID POSSIBLE SHOCK HAZARD, BECAUSE OF LIVE CHASSIS.

THE CHASSIS OF THIS RECEIVER IS DIRECTLY CONNECTED TO THE AC POWER LINE.

SAFETY-RELATED COMPONENT WARNING !!

COMPONENTS IDENTIFIED BY SHADING AND MARK Δ ON THE SCHEMATIC DIAGRAMS, EXPLODED VIEWS AND IN THE PARTS LIST ARE CRITICAL TO SAFE OPERATION. REPLACE THESE COMPONENTS WITH SONY PARTS WHOSE PART NUMBERS APPEAR AS SHOWN IN THIS MANUAL OR IN SUPPLEMENTS PUBLISHED BY SONY. CIRCUIT ADJUSTMENTS THAT ARE CRITICAL TO SAFE OPERATION ARE IDENTIFIED IN THIS MANUAL. FOLLOW THESE PROCEDURES WHENEVER CRITICAL COMPONENTS ARE REPLACED OR IMPROPER OPERATION IS SUSPECTED.

SECTION 1 GENERAL

1-1. FEATURES

Four color systems available

The monitor can display PAL, SECAM, NTSC_{4.43} and NTSC_{4.43*} signals. The appropriate color system is selected automatically.

* A signal of NTSC_{4.43} is used for playing back NTSC recorded video cassettes with a video tape recorder/player especially designed for use with this system.

Blue only picture

The picture can be displayed in blue and black only. This facilitates hue adjustment and the observation of video noise.

Analog RGB/component input connectors

Analog RGB or component (Y, R-Y, and B-Y) signals from video equipment can be input through these connectors.

Beam current feedback circuit

The built-in beam current feedback circuit assures stable white balance.

Comb filter

When NTSC video signals are received, a comb filter activates to increase the resolution, resulting in fine picture detail without color spill or color noise.

Automatic termination of BNC connectors

The rear BNC input connectors are internally terminated 75 ohms when nothing is connected to the output connector (VIDEO OUT). However, this impedance limit is automatically removed when a cable is plugged into the output connector, and the signal is looped-through as it is.

EIA standard 19-inch rack mounting

By using an MB-507 mounting bracket (not supplied), the monitor can be mounted in an EIA standard 19-inch rack. For details on mounting, see the instruction manual of the MB-507.

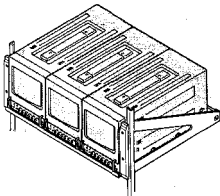

1-2. LOCATION AND FUNCTION OF PARTS AND CONTROLS

Front

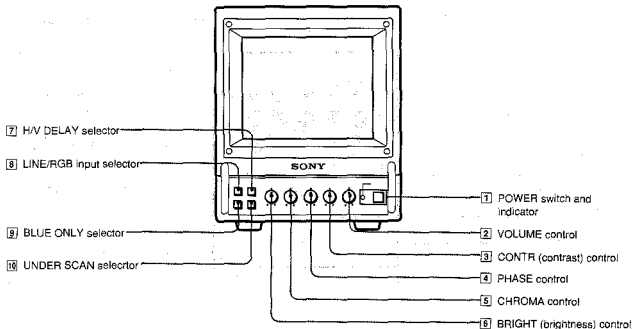
**1 POWER switch and indicator**

Depress to turn the monitor on. The indicator will light up in green.

The POWER indicator also functions as the battery indicator. When the internal battery becomes weak or the power supplied through the DC12V IN jack decreases, the indicator flashes.

2 VOLUME control

Turn this control clockwise or counterclockwise to obtain the desired volume.

3 CONTR (contrast) control

Turn clockwise to make the contrast stronger and counterclockwise to make it weaker.

4 PHASE control

Turn clockwise to make the skin tones greenish and counterclockwise to make them purplish.

5 CHROMA control

Turn clockwise to make the color intensity stronger and counterclockwise to make it weaker.

Note

- The PHASE and CHROMA control settings have no effect on an analog RGB signal.
- The PHASE control has no effect on component signals.
- The PHASE control setting is effective only for the NTSC system.

6 BRIGHT (brightness) control

Turn clockwise for more brightness and counterclockwise for less.

7 H/V DELAY selector

Depress this button to observe the horizontal and vertical sync signals at the same time. The horizontal sync signal is displayed in the left quarter of the screen; the vertical sync signal is displayed near the center of the screen.

8 LINE/RGB input selector

Select the program to be monitored. Keep this button released (LINE) for a signal fed through the LINE connectors. Depress this button (RGB) for a signal fed through the RGB/COMPONENT connectors.

9 BLUE ONLY selector

Depress this button to turn off the red and green signals. A blue signal is displayed as an apparent monochrome picture on the screen. This facilitates "chroma" and "phase" control adjustments and the observation of video noise.

10 UNDER SCAN selector

Depress this button for underscanning. The display size is reduced by approximately 3% so that four corners of the raster are visible.

Rear

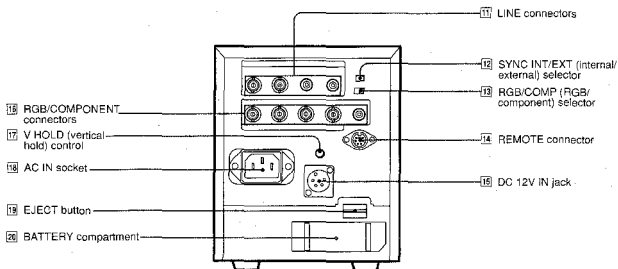
**11 LINE connectors**

To monitor the signal fed through these connectors, keep the LINE/RGB selector on the front panel released (LINE).

VIDEO IN (BNC): Connect to the video output of a video camera, VCR or other video equipment.

VIDEO OUT (BNC): Loop-through output of the VIDEO IN connector. Connect to the video input of a VCR or another monitor.

AUDIO IN (phono jack): Connect to the audio output of a VCR or a microphone (through a suitable microphone amplifier).

AUDIO OUT (phono jack): Loop-through output of the AUDIO IN connector. Connect to the audio input of a VCR or another monitor.

12 SYNC INT/EXT (sync internal/external) selector

Select the internal or external sync.

13 RGB/COMP (RGB/component) selector

Select the RGB or component (Y, R-Y and B-Y) signal. Keep the LINE/RGB input selector on the front panel depressed (RGB), otherwise the RGB/COMP selector does not function.

14 REMOTE connector (8-pin mini DIN)

Connect to a remote controller. For the pin assignment of this connector, see "Specifications" on page 5.

15 DC 12V IN jack (XLR, 4 pin)

Connect the Sony AC-500/500CE AC power adaptor (not supplied).

16 RGB/COMPONENT input connectors R/R-Y, G/Y, B/B-Y, (BNC), AUDIO (phono):

To monitor a signal fed through these connectors, depress the LINE/RGB selector on the front panel (RGB).

To monitor the analog RGB signal

Connect to the analog RGB signal outputs of a video camera. Set the RGB/COMP selector to RGB.

To monitor the component signal

Connect to the R-Y/Y/B-Y component signal outputs of a Sony Betacam video camera. Set the RGB/COMP selector to COMP (component).

SYNC (BNC):

To operate the monitor on an external sync, connect the reference signal from a sync generator. Set the SYNC INT/EXT selector to EXT (external).

17 V HOLD (vertical hold) control

Turn to stabilize the picture if it rolls vertically.

18 AC IN socket

Connect the supplied AC power cord to this socket and to a wall outlet.

19 EJECT button

Press the EJECT button upwards to remove the battery pack.

20 BATTERY compartment

Insert the NP-1A/1B battery pack (not supplied).

1-3. POWER SOURCES

House Current

Connect the supplied AC power cord to the AC IN socket and to a wall outlet.

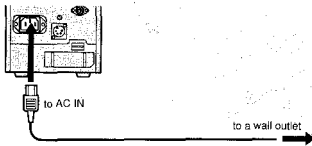

When the AC power cord is plugged into the AC IN socket, the battery pack (if installed) or the AC power adaptor (if connected) is automatically disconnected.

To connect an AC power cord securely with AC plug holders

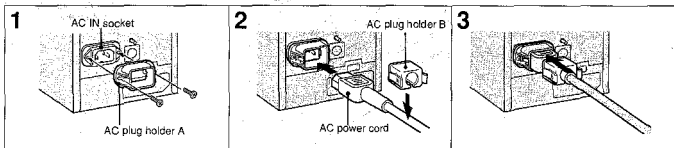

- 1 Remove the AC IN socket screws and then use them to attach AC plug holder A (supplied) to the AC IN socket.
- 2 Plug the power cord to the AC IN socket. Then, attach the supplied AC plug holder B on top of the AC power cord.
- 3 Slide AC plug holder B over the cord until it connects with AC plug holder A.

To remove the AC power cord

Pull out AC plug holder B by squeezing the left and right sides.

Rechargeable Battery

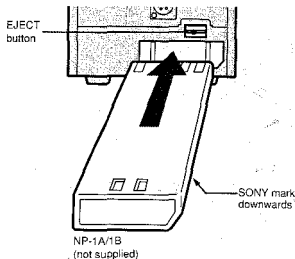

To remove the battery pack, press the EJECT button upwards.

For charging, use the BC-1WA battery charger (not supplied) for the NP-1A or the BC-1WB for the NP-1B.

Note

Make sure that the AC power cord and the AC power adaptor are disconnected from the monitor. Otherwise, the monitor cannot operate on the battery pack.

SECTION 2 DISASSEMBLY

2-1. CABINET REMOVAL

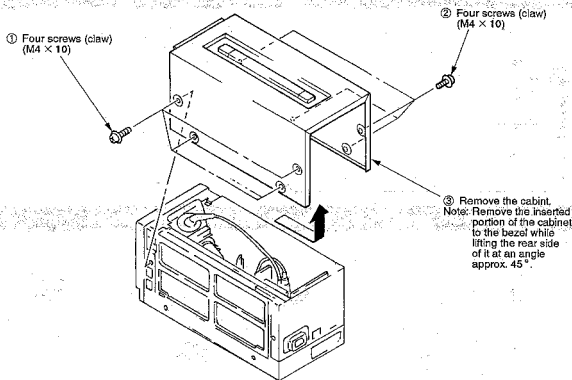

2-2. B BOARD REMOVAL

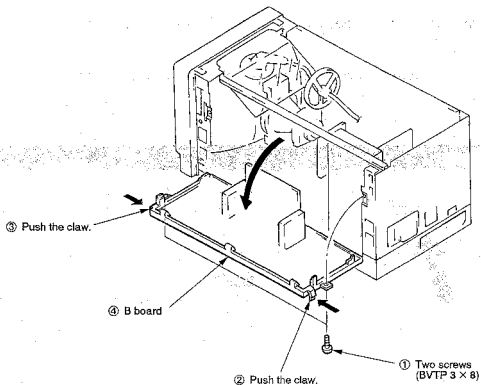

2-3. SWITCHING REGULATOR REMOVAL

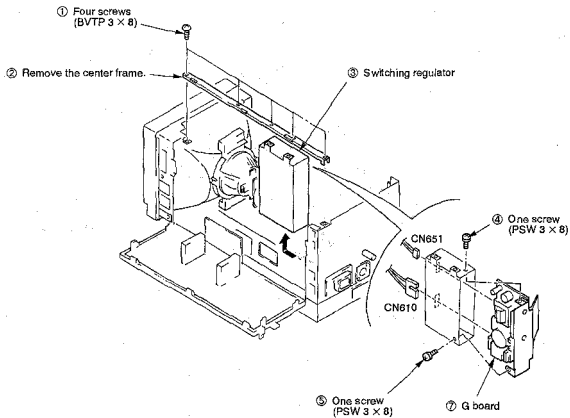

2-4. D BOARD REMOVAL

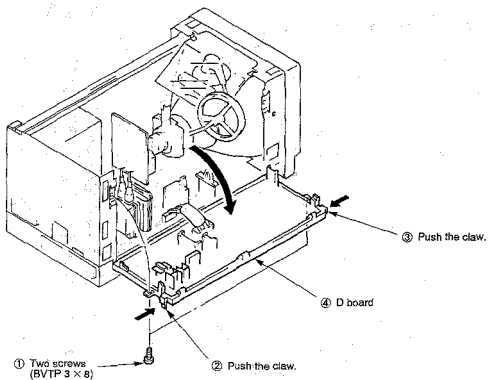

2-5. P BOARD REMOVAL

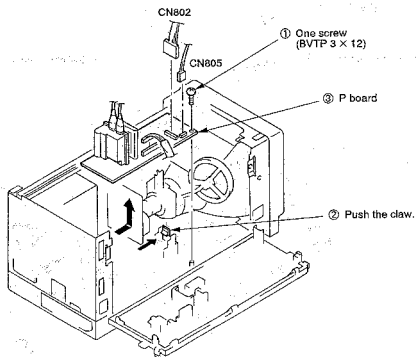

2-6. REAR ASSY REMOVAL

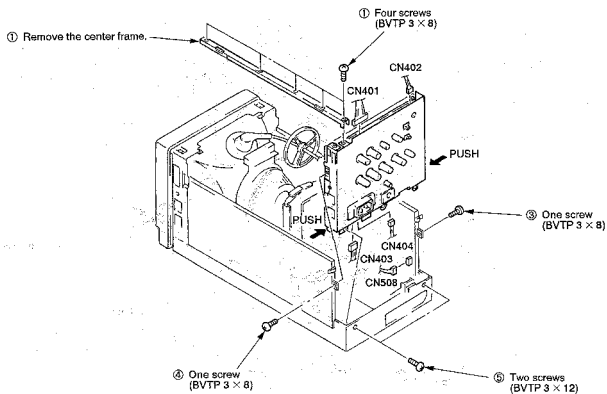

2-7. HB AND FC BOARDS REMOVAL

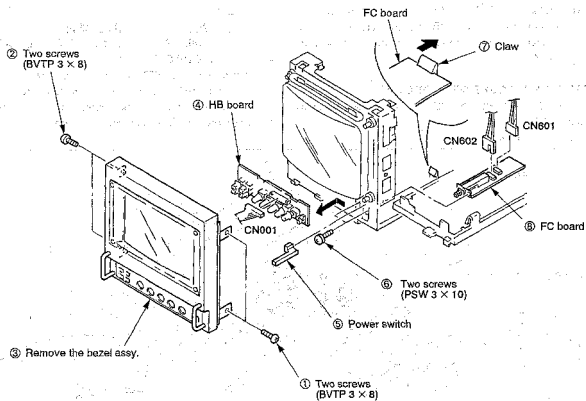

2-8. PICTURE TUBE REMOVAL

Note : Caution for ANODE CAP installation.

When you replace PICTURE TUBE or FBT, remove RTV on ANODE CAP so that PICTURE TUBE and FBT can be separated. Please adhere picture tube and anode cap in accordance with the following procedure.

ADHERING PROCEDURE OF ANODE CAP.

1. Clean PICTURE TUBE ANODE CAP with ethanol to remove original RTV.
2. Dry clean face with air.

3. Use KE-490RTV (RTV silicone adhesive, SHIN-ETSU CHEMICAL).

Part No.	Description
7-322-065-19	Silicone (RTV) KE-490W

4. Install ANODE CAP.
5. Adequately apply RTV to the entire picture tube anode area, place the anode cap onto the picture tube and push it down securely so that no air pockets remain beneath the cap.
6. Dry more than 12 hours at room temperature.

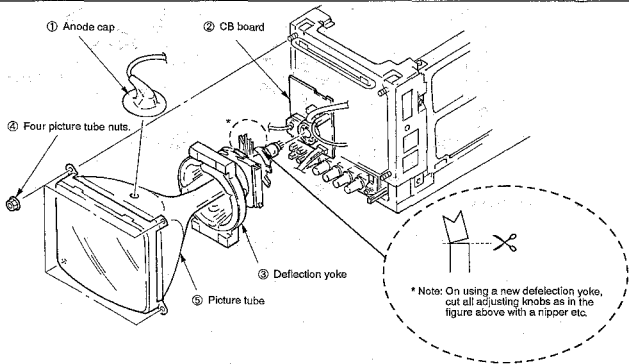

REMOVAL OF ANODE-CAP REMOVING PROCEDURES

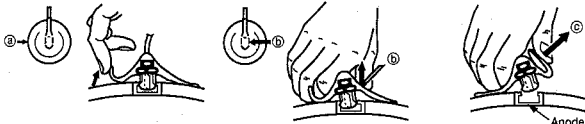

- ① Turn up one side of the rubber cap in the direction indicated by the arrow (a).
- ② Using a thumb pull up the rubber cap firmly in the direction indicated by the arrow (b).
- ③ When one side of the rubber cap is separated from the anode button, the anode-cap can be removed by turning up the rubber cap and pulling up it in the direction of the arrow (c).

HOW TO HANDLE AN ANODE-CAP

- ① Don't hurt the surface of anode-caps with sharp shaped material!
- ② Don't press the rubber hardly not to hurt inside of anode-caps!
A metal fitting called as shatter-hook terminal is built in the rubber.
- ③ Don't turn the foot of rubber over hardly!

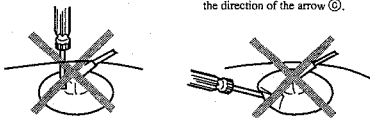

SECTION 3 SET-UP ADJUSTMENTS

- The following adjustments should be made when a complete realignment is required or a new picture tube is installed.
- These adjustments should be performed with rated power supply voltage unless otherwise noted.

The control and switch below should be set as follows unless otherwise noted:

CONTRAST control	80%
BRIGHTNESS control	50%

Perform the adjustments in order as follows:

- 3-1. Beam Landing
- 3-2. Convergence
- 3-3. Focus
- 3-4. White Balance

Note: Test equipment Required.

1. Color Bar/Pattern Generator
2. Degausser
3. Color Analyzer (Minolta)
4. Luminance Level Meter

3-1. BEAM LANDING

Precaution

- Set the side of the unit with the PICTURE TUBE so that it faces east or west in order to reduce the influence of external magnetic force.
- Turn the power switch for the unit ON and erase the magnetic force using a degausser.

(1) Beam Landing

- Receive an entirely white signal with the pattern generator.
CONTRAST MAX.
BRIGHTNESS set easy to observe
- Adjust the white balance, G2 voltage and convergence roughly.
- Loosen the deflection yoke mounting screw, and set the purity control to the center as shown in Fig.3-1.
- Switch over the pattern generator to green.
- Move the deflection yoke backward, and adjust with the purity control so that green is in the center and blue and red are at the sides, evenly. (Fig.3-2)
- Move the deflection yoke forward, and adjust so that the entire screen becomes green. Repeat 5 to 7 as to red and blue.
- When landing at the corners is not right, correct by using the magnet. (Fig.3-3)
- When the position of the deflection yoke is determined, tighten it with a deflection yoke mounting screw.

CAUTION; When correction magnet is used, be sure to degauss the unit.

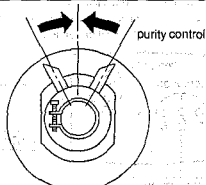

Fig.3-1



Fig.3-2

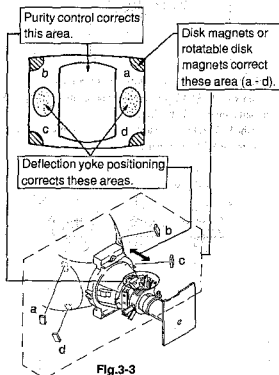
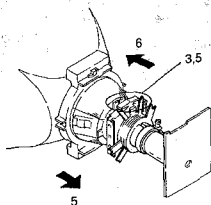

Fig.3-3

3-2. CONVERGENCE

(1) Horizontal and vertical Static Convergence Adjustment on the Center of Screen.

- Before starting, perform V. SIZE, V. CENT, H. SIZE, H. CENT and Screen Distortion Adjustment rightly.

(Static Convergence Adjustment)

1. Receive a dot signal, setting BRIGHTNESS minimum and set CONTRAST to normal.
2. Adjust H.STAT VR to coincide red, green and blue dots on the center of screen. (Horizontal movement)
3. Adjust V.STAT magnet to coincide red, green and blue dots on the center of screen. (Vertical movement)

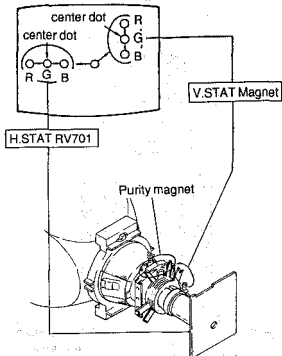

- * If the red, green and blue dots do not coincide on the center of screen with H.STAT VR, perform adjustment using V.STAT at the same time while tracking. (Tilt the V.STAT magnet and adjust static convergence to open or close the V.STAT magnet.)

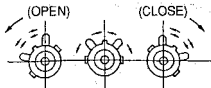

4. When the V.STAT magnet is moved in the direction of arrow A and b, red, green and blue dots move as shown below.

① When moving the V.STAT Magnet open or close.

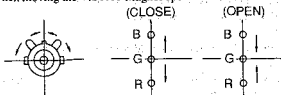

② When moving the V.STAT magnet counterclockwise.



③ When moving the V.STAT magnet clockwise.

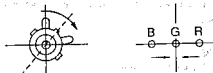

④ When tilt the V.STAT magnet and open or close.

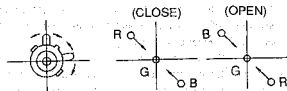

- * If the red and green dots do not coincide with blue dot, adjustment with BMC (6-poles) magnet.

5. HMC and VMC correction for BMC (6-Poles) magnet.

- ① HMC (Horizontal Misconvergence) correction and motion of the Electron Beam with the BMC (6-poles) magnet.

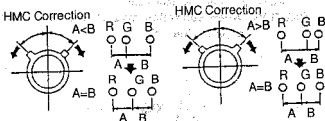

- ② VMC (Vertical Misconvergence) correction and motion of the Electron Beam with the BMC (6-poles) magnet.

VMC Correction (A) VMC Correction (B)

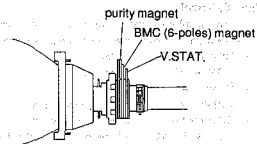
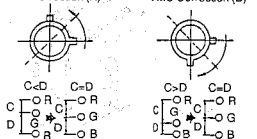

(2) Horizontal and Vertical Dynamic Convergence Adjustment at the Environs of the Screen (Dynamic Convergence Adjustment)

1. When there is misconvergence at the sides of screen, adjust for best convergence as follows by moving the deflection yoke.
2. Loosen deflection yoke screw. Remove deflection yoke spacers. Move the deflection yoke for best convergence. Tighten the deflection yoke screw. Install three deflection yoke spacers.

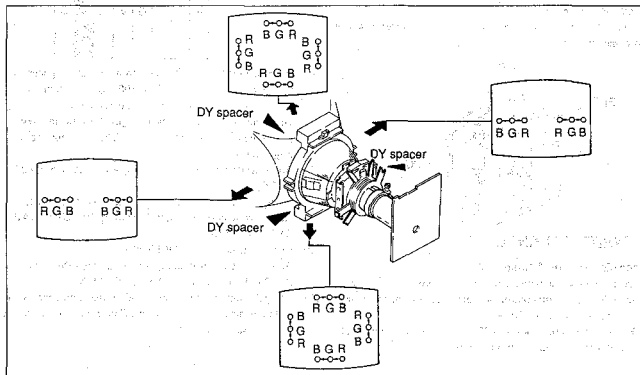

Screen-corner Convergence

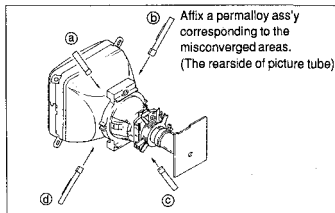
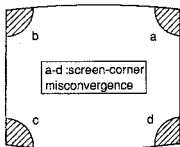

3-3. FOCUS

1. Receive the broadcast.
2. CONTRAST → Normal
3. Adjust FOCUS control so that the focus on the center of screen becomes to the best.

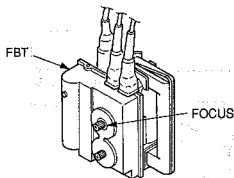

3-4. WHITE BALANCE

[Screen (G2) Voltage Adjustment]

1. Receive a dot signal with the pattern generator.
2. Adjust R. G. B cut-off controls so that respective cathode voltage against ground becomes 103V DC.
3. Observing the screen, adjust SCREEN control so that the background of the dot signal is bright dimly.

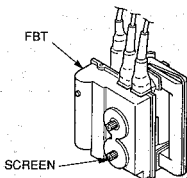

[White Balance]

1. Receive a color-bar pattern signal with the pattern generator. (Make black and white screen by chroma switch off.)
2.
 - BRIGHTNESS 50%
 - CONTRAST Minimum
 - CHROMA 50%
 - DRIVE control Mechanical center
 - BKG control Mechanical center
3. Adjust RV118 (SUB BRT) on B board so that the blue stripe portion on the color-bar pattern signal is bright dimly.

color-bar pattern

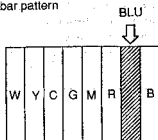

4. Receive an entirely white signal from the pattern generator.
5. CONTRAST 70% (90 degree clockwise from mechanical center.)
6. Using the luminance level meter, adjust the luminance level of the pattern generator becomes 3 Nits. (The condition the screen is bright dimly.)
7. Adjust white balance at cut-off using RV119 (G-C/O) and RV121 (B-C/O).
8. Change the all-white signal luminance level to 100 IREs.
9. Adjust white balance at high-light using RV120 (G-GAIN) and RV121 (B-GAIN).
10. Change the unit to blue ONLY mode.
11. Adjust white balance (at high-light) in blue ONLY mode using RV124 *R-GAIN/BL) and RV125 (G-GAIN/BL).
12. Using the luminance level meter, adjust the luminance level of the pattern generator becomes 8 Nits. Confirm that white balance at cut-off is satisfactory.

14-00000

MEMORANDUM FOR THE DIRECTOR

MEMO

SECTION 4

SAFETY RELATED ADJUSTMENTS

4-1. SAFETY RELATED ADJUSTMENTS

B+ ADJUSTMENT AND B+ MAX CHECK FOR SERVICING (RV651)

The following adjustments should always be performed when replacing the following components (marked with on the schematic diagram).

on G board : (Power supply block)

IC601, IC651, PH601, C654, R653, R655, R656, R657, RV651.

1. Input the AC power supply voltage $240V_{\pm 10\%}$ V.
2. Input the monoscope signal.
3. Set as follows.
 - CONTRAST 80%
 - BRIGHTNESS 50%
4. Connect the digital multimeter to RY1601 pin-① on the D board.
5. Adjust RV651 on the G board so that the +B voltage becomes 40.0 ± 0.1 V.
6. After adjusting RV651, fix it with an epoxy.
7. Input the AC power supply voltage $240V_{\pm 10\%}$ V.
8. Input the dot signal.
9. Set as follows.
 - CONTRAST Minimum
 - BRIGHTNESS Minimum
10. Check that the B+ voltage is below 41.9V.
If it is above this value, repeat from step 1.

B+ MAX IN DC POWER INPUT MODE, CONFIRMATION (RV1603)

The following adjustments should always be performed when replacing the following components (marked with on the schematic diagram).

on D board :

Q1601, Q1602, Q1603, D1601, D1602, D1603, D1604, D1605, C1601, C1602, R1601, R1602, R1603, R1604, R1605, R1606, R1607, R1608, R1629, R1628, R1630, RV1601, RV1603.

1. Supply DC $12V_{\pm 0.4}$ V from DC 12V IN connector.
2. Receive a dot signal.
3. • CONTRAST Minimum
• BRIGHTNESS Minimum
4. Connect a digital multimeter to C1605 positive + side of D board.
5. Turn RV1601 on the D board fully clockwise. Confirm that the voltage of C1605 + pin is less than 41.9V DC.
6. If step 5 is not satisfied, readjust the RV1603. After adjusting, fasten RV1603 in place with epoxy.

HOLD-DOWN CIRCUIT CONFIRMATION (RV833) AND READJUSTMENTS

The following adjustments should always be performed when replacing the following components (marked with on the schematic diagram).

on D board:

IC502, Q833, Q834, Q835, Q836, D835, D836, C519, C843, C844, C845, C846, C847, C848, RV833, R523, R850, R851, R852, R853, R854, R855, R856, R857, R858, R859, R861, R862, R863.

on P board: NL801, T802 (FBT), C814.

1. Receive an entire white signal.
2. • CONTRAST Maximum
• BRIGHTNESS Maximum
3. Connect a digital multimeter to the TP85 (CN503 pin-⑥).
4. Confirm the voltage is 14.1 ± 3.0 V DC.
5. Receive a dot signal.
6. Connect an ammeter between D board CN503 pin-⑥ and P board CN801 pin-③.
7. Adjust BRIGHTNESS and CONTRAST so that the current is $I_{ABL} = 160 \pm 30 \mu A$.
8. Apply an external DC voltage gradually to TP85. When the voltage becomes $18.5V \pm 0.1$ V DC, confirm the HOLD-DOWN circuit operates immediately and raster disappears.
9. When external DC voltage at TP85 becomes $17.5V \pm 0.1$ V DC, confirm the HOLD-DOWN circuit doesn't operate.
10. Receive an entire white signal.
11. Adjust with BRIGHTNESS and CONTRAST controls so that the current is $I_{ABL} = 520 \pm 30 \mu A$.
12. Apply DC voltage of $17.8V \pm 0.1$ V to TP85. Confirm the HOLD-DOWN circuit operates immediately and raster disappears.
13. With the same set-up as steps 10 and 11, supply $16.8V \pm 0.1$ V DC to TP85. Confirm that the HOLD-DOWN circuit doesn't operate.
14. When above specifications are not satisfied, readjust RV833. After adjusting, fasten RV833 in place with epoxy.

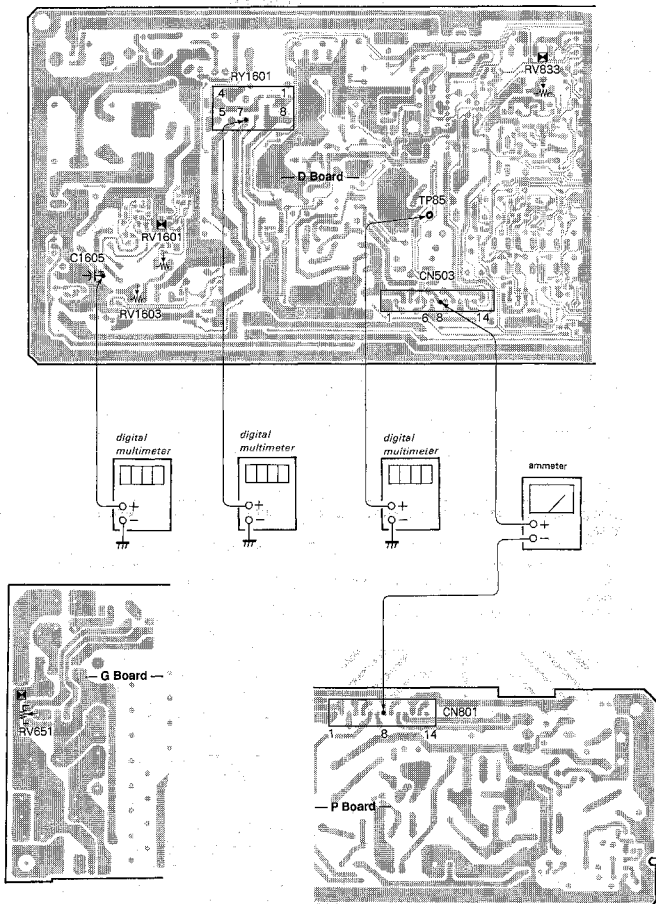

SECTION 5 CIRCUIT ADJUSTMENTS

5-1. D BOARD ADJUSTMENTS

—D BOARD (COMPONENT SIDE)—

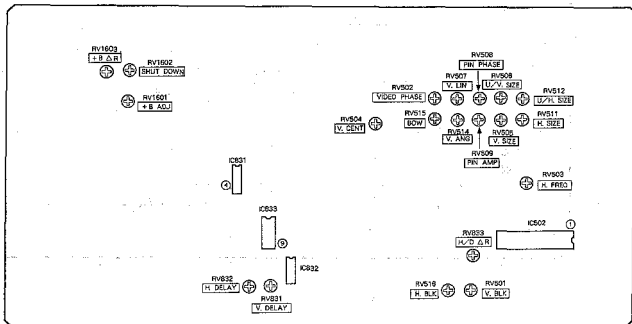

HORIZONTAL OSCILLATION FREQUENCY ADJUSTMENT (RV503)

1. Receive a monoscope signal.
2. Connect pin ① of IC502 to ground with 100 μ F/16V electrolytic capacitor.
3. Adjust RV503 (H.FREQ) so that the screen streaming stops.



SCREEN PHASE ADJUSTMENTS (RV502, RV512, RV516)

1. Receive a monoscope signal.
2. Set U/S (Under Scan) switch to Under mode.
3. • CONTRAST Minimum
• BRIGHTNESS Maximum.
4. Adjust RV512 (U/H. SIZE) so that the white frame of monoscope signal becomes visible.
5. Adjust RV516 (H.BLK) for minimum BLKG width so that all the deflection area becomes visible.
6. Adjust RV502 (VIDEO PHASE) so that the monoscope's white frames should have equal width.

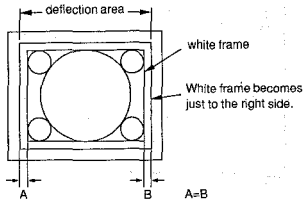

H.V BLK ADJUSTMENTS (RV501, RV516)

1. Receive a monoscope signal.
2. Set U/S (Under Scan) switch to Under mode.
3. • CONTRAST Minimum
• BRIGHTNESS Maximum.
4. V. BLK Adjustment (RV501)
- (1) Adjust RV501(V. BLK) so that the upper side white frame of monoscope signal is not blanked.

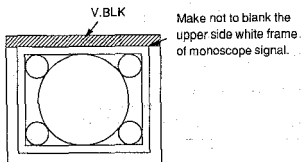

5. H. BLK Adjustment (RV516)
- (1) Adjust with RV516 (H. BLK) so that the left end white vertical line of the white frame of monoscope signal is not blanked as following figure.

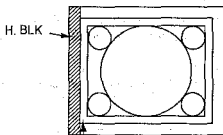

Make not to blank the left end white vertical line of the white frame of monoscope signal.

VERTICAL DEFLECTION PART ADJUSTMENTS (RV504, RV505, RV506, RV507)

1. Receive a monoscope signal.
2. • CONTRAST 70%
• BRIGHTNESS 50%
3. Adjust RV505 (V. SIZE) so that the vertical size of monoscope signal becomes 12 frames.

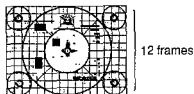

4. Adjust RV507 (V. LIN) the vertical linearity.

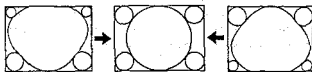

5. Adjust RV504 (V. CBNT) the vertical position.

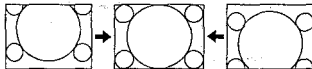

6. V. SIZE ADJUSTMENT (RV505)
- (1) Adjust RV505 (V. SIZE) so that the vertical size of monoscope signal becomes 11.75 ± 0.2 frames.
7. V. SIZE IN UNDERSCAN MODE ADJUSTMENT (RV506)
- (1) Set U/S (Under Scan) switch to Under mode.
- (2) Adjust the Under V. SIZE with RV506 (U/V. SIZE) as follows.

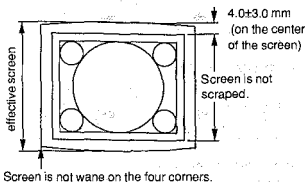

HORIZONTAL DEFLECTION PART ADJUSTMENTS (RV508, RV509, RV511, RV514, RV515, RV801/P board)

1. Receive a monoscope signal.
2. • CONTRAST 70%
• BRIGHTNESS 50%
3. H. CENT Adjustment (RV801 on P board)
- (1) Adjust RV801 on P board (H. CENT) the horizontal position.

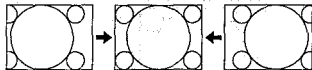

4. H. SIZE Adjustment (RV511)
- (1) Adjust RV511 (H. SIZE) the horizontal size of 16 frames of monoscope signal.

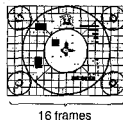

5. PIN AMP. PIN PHASE, V. ANG, BOW ADJUSTMENTS (RV508 RV509, RV514, RV515)

Adjust RV514 (V. ANG) and RV515 (BOW) to correct vertical angular distortion and bow distortion. Adjust RV509 (PIN AMP) and RV508 (PIN PHASE) so that vertical lines become straight.

• V. ANG (RV514)



• BOW (RV515)



• PIN AMP (RV509)



• PIN PHASE (RV508)



6. H. SIZE ADJUSTMENT (RV511)

(1) Adjust RV511 (H. SIZE) so that the horizontal size becomes 16 ± 0.2 frames.

7. UNDERSCAN MODE H. SIZE ADJUSTMENT (RV512)

- (1) Set U/S (Under Scan) switch to Under mode.
- (2) Adjust RV512 (U/H. SIZE) the Under H. SIZE as shown in the figure.

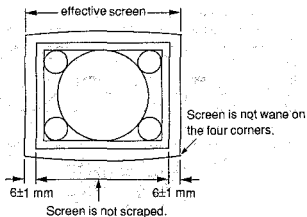

H V DELAY ADJUSTMENT (RV831, RV832)

1. Receive a monoscope signal.
2. • CONTRAST 70%
• BRIGHTNESS 50%
3. Set H V DELAY switch to DELAY mode.
4. H. DELAY Adjustment (RV832)
- (1) Connect an oscilloscope to pin-④ of IC831.
- (2) Adjust RV832 (H. DELAY) to becomes $41 \pm 1 \mu\text{Sec}$.

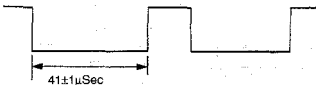

5. V. DELAY Adjustment (RV831)

- (1) Connect an oscilloscope to pin-② of IC831.
- (2) Adjust RV831 to become $8.0 \pm 0.4 \text{msec}$ as follows.

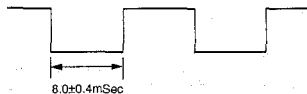

SHUT-DOWN VOLTAGE ADJUSTMENT (RV1602)

1. Fully rotate RV1602 in the direction that does not shut-down.
2. Supply a $9.4\text{V} \pm 0.1\text{V}$ voltage to the C1602 side of L1602 on the D board.
3. Turn AC power switch ON.
4. Rotate D board RV1602 (SHT DOWN) slowly to the point that shuts-down the unit.

B+ VOLTAGE DURING DC OPERATE MODE, ADJUSTMENT (RV1601)

1. Supply $\text{DC } 12\text{V} \pm 0.2\text{V}$ to DC 12V IN connector.
2. Receive a monoscope signal.
3. • CONTRAST 80%
• BRIGHTNESS 50%
4. Connect a digital voltmeter to C1605 + positive side on D board.
5. Adjust RV1601 on the D board for $40.0 \pm 0.1\text{V DC}$.

5-2. B BOARD ADJUSTMENTS

-B BOARD (COMPONENT SIDE)-

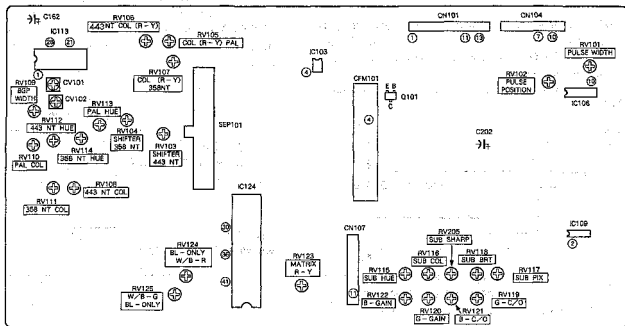

-B BOARD (CONDUCTOR SIDE)-

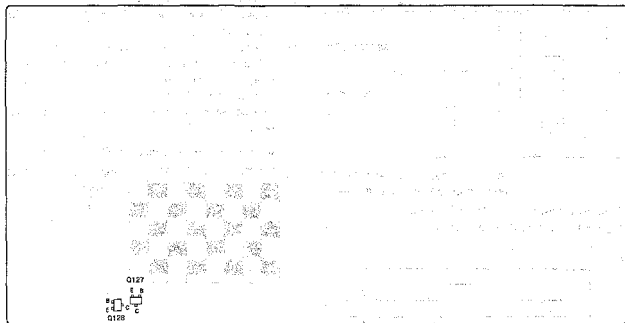

**PRIMARY COLOR MATRIX ADJUSTMENT
(RV115, RV116, RV123)**

1. Supply component color bar signal (75% chroma color bar) to the equipment so that Y signal is supplied to EXT SYNC and R-Y signal to R-Y connectors. Operate the equipment in external sync mode.
2. Connect oscilloscope to IC124 pin-② (B-OUT).
3. Adjust RV115 (SUB HUE) to obtain the Blue output as shown in figure.

(B-OUT)

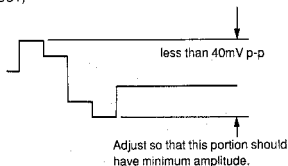

4. Supply component color bar signal (75% color bar) to the component input connector to feed R-Y and B-Y signals. Operate the equipment in internal SYNC mode.
5. Connect oscilloscope to IC124 pin-③ (SUB-COL). Adjust RV116 (SUB-COL) so that waveform peaks should have the same level.

(B-OUT)

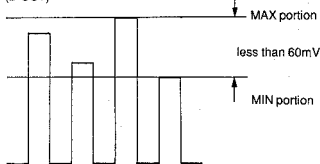

(Adjust so that the first and the 4th peaks should have the same level.)

6. Connect oscilloscope to IC124 pin-④ (R-OUT).
7. Adjust RV123 ((R-Y)-IN) so that waveform peaks should have the same level.

(R-OUT)

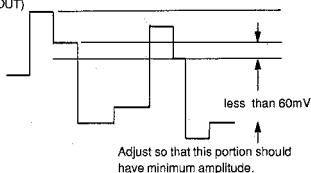

BURST GATE PULSE WIDTH ADJUSTMENT (RV109)

1. Receive color bar signal.
2. Connect dual trace oscilloscope to CN104 connector pin-⑩ (COMP-SYNC) and IC113 (M51279) pin-① (BGP-WIDTH). Adjust RV109 (BGP-WIDTH) to obtain the relationship as shown in the figure.

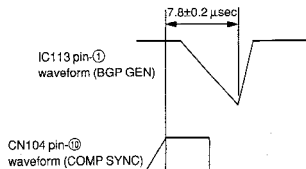

VXO ADJUSTMENT (CV101, CV102)

1. 3.58MHz VXO adjustment (CV101)
 - (1) Receive NTSC color bar signal.
 - (2) Connect +5V power line to IC113 pin-② (ID-FILT-REP) via a 4700Ω resistor.
 - (3) Ground IC109 pin-② by connecting it to ground.
 - (4) Ground C162 - negative side by connecting it to ground.
 - (5) Connect frequency counter to IC113 pin-②. Adjust CV101 (358FO) for 3579545±20Hz. (This adjustment can be alternatively done by observing screen as below.)

Adjust color synchronization by CV101 (358FO).

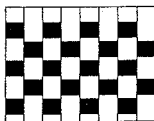

Adjust so that color stripes disappear and the hue change is stabilized extremely.

2. 4.43MHz VXO adjustment (CV102)

- (1) Receive PAL colour bar signal.
- (2) Connect +12V power line to IC109 pin-②.
- (3) Connect frequency counter to IC113 pin-②. Adjust CV102 (443FO) for $4433619 \pm 20\text{Hz}$.

(This adjustment can be alternatively done by observing screen as below.)

Adjust colour synchronization by CV102(443FO).

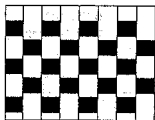

Adjust so that colour stripes disappear and the hue change is stabilized extremely.

NTSC COMB FILTER ADJUSTMENT (RV1, T1/CFM101 BOARD)

1. Receive NTSC 3.58 color bar signal.
2. Connect an oscilloscope to C202 - negative side.
3. Confirm the Y OUT is $0.78 \pm 0.5 \text{ Vp-p}$.
4. Confirm the residual chroma is 32 mVp-p below. If it is above 35 mVp-p, adjust with RV1 and T1 on CFM201 board while tracking.

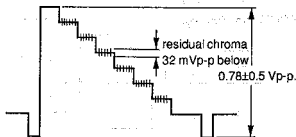

NTSC COLOR DEMODULATION ADJUSTMENT (RV114, RV111, RV104, RV107)

1. NTSC 3.58MHz - HUE adjustment (RV114)
 - (1) Supply NTSC color bar signal including burst and R-Y component. (For example, Tektronix 1410SG output color bar signal with B-Y component removed.)
 - (2) Connect an oscilloscope to Q128 emitter (B-Y OUT).
 - (3) Adjust RV114 (358NT - HUE) so that all the waveform peaks should have equal amplitude (look flat) except burst. (Level difference should be less than 10mV p-p.)

2. NTSC 3.58MHz - COLOR adjustment (RV111)

- (1) Receive NTSC 3.58 color bar signal.
- (2) Connect an oscilloscope to IC124 pin-③ (B-OUT).
- (3) Adjust RV111 (358NT-COL) so that waveform peaks should have the same level (most flat).

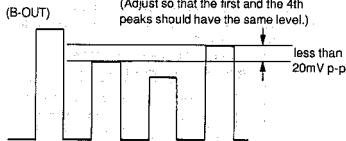

3. NTSC 3.58MHz - COLOR (R-Y) adjustment (RV104, RV107)

- (1) Receive the color bar signal.
- (2) Connect an oscilloscope to the Q127 emitter (R-Y OUT), and adjust RV104 (358NT-SHIFT) so that the output of the burst section (B-Y axis signal output) becomes 0.
- (3) Connect an oscilloscope to IC124 pin-④ (R-OUT). Adjust RV107 (358NT-COL (R-Y)) so that the level difference should be minimum.

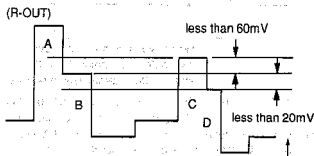

(Adjust for B=D. [less than 20mV] Also level difference between B and C should be less than 60mV.)

NTSC 4.43MHZ COLOR DEMODULATION ADJUSTMENT (RV108,RV112,RV103,RV106)

1. NTSC 4.43MHz - COLOR adjustment (RV108,RV112)
 - (1) Receive NTSC 4.43 color bar signal (75% color bar).
 - (2) Connect an oscilloscope to IC124 pin-② (B-OUT).
 - (3) Adjust RV108 (443NT-COL) so that waveform peaks should have the same level (most flat).

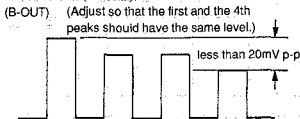

- (4) When cyan and magenta have level difference, adjust RV112 (443NT-HUE) and RV108 (443NT-COL) alternatively to remove, by tracking.

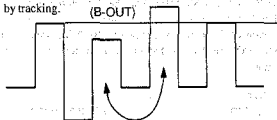

When cyan and magenta have level difference, adjust RV112 and RV108 alternatively to remove.

2. NTSC 4.43MHz - COLOR (R-Y) adjustment (RV103, RV106)
 - (1) Receive the NTSC 4.43 color bar signal (75%, chroma color bar).
 - (2) Connect an oscilloscope to the Q127 emitter (R-Y OUT), and adjust RV103(443NT-SHIFT) so that the output of the burst section (B-Y axis signal output) becomes 0.
 - (3) Connect an oscilloscope to IC124 pin-④ (R-OUT). Adjust RV106 (443NT-COL (R-Y)) so that the level difference should be minimum.

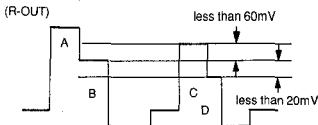

(Adjust for B=D. [less than 20mV] Also level difference between B and C should be less than 60mV.)

PAL COLOR DEMODULATION ADJUSTMENT (RV113,RV2/SEP101, RV110,RV105,RV205)

1. PAL PHASE Adjustment (RV113,RV2/SEP101)
 - (1) Receive the special PAL color-bar.
 - (2) Connect an oscilloscope to emitter of Q127 (R-Y OUT).
 - (3) Adjust RV113 (PAL-PHASE) so that B-Y (0/180°) anti-PAL portion (in the R-Y demodulated output) becomes "0" (flat) as following figure.

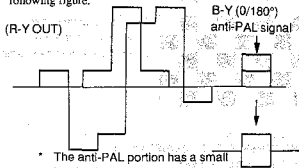

The anti-PAL portion has a small level difference in every other horizontal period. So, adjust so that average becomes "0".

- (4) Connect an oscilloscope to emitter of Q128 (B-Y OUT).
- (5) Adjust RV2 inside SEP101 so that R-Y (90°/90°) anti-PAL portion (in B-Y demodulated output) becomes "0" (flat) as following figure.

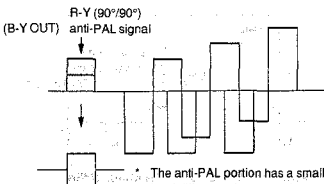

The anti-PAL portion has a small level difference in every other horizontal period. So, adjust so that average becomes "0".

(For the adjustments of (3) and (5), it is also possible to set the color level to MAX with the chroma adjusting knob of the unit and erase the color of the anti-pal signal section.)

2. PAL COLOR ADJUSTMENT (RV110)

- Receive PAL color bar signal (75% color bar).
- Connect an oscilloscope to IC124 pin-⑨ (B-OUT).
- Adjust RV110 (PAL-COL) so that waveform peaks should have the same level (most flat).

(B-OUT) (Adjust so that the first and the 4th peaks should have the same level.)

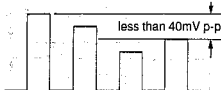

3. PAL-COLOR-(R-Y) ADJUSTMENT (RV105)

- Connect an oscilloscope to IC124 pin-⑩ (R-OUT).
- Adjust RV105 (PAL-COL-(R-Y)) so that waveform peaks should have the same level (most flat).

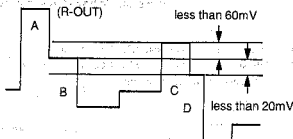

(Adjust for B=D. [less than 20mV] Also level difference between B and C should be less than 60mV.)

SUB-SHARP ADJUSTMENT (RV205)

- Receive a sweep signal (or multi-burst).
 - Bandwidth should be more than 10MHz (flat).
 - Composite sync should be included.
 - Turn burst off.
- Connect an oscilloscope to IC124 pin-⑬ (G-OUT).
- Adjust RV205 (SUB-SHARP) as shown.

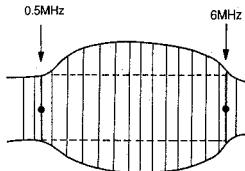

Example of sweep signal output waveform

[specification]

6MHz/0.5MHz=0±0.5dB

CHROMA H PULSE POSITION ADJUSTMENT (RV101, RV102)

- Receive the SECAM color bar signal.
(The left edge of the screen should not be colored.)
- Set to the under-scan mode.
- Adjust RV101 (PLUSE-WIDTH) until the point immediately before the color on the left edge of the screen disappears.
- Release the under-scan mode.
- Set the HV DELAY mode.
- Adjust RV102 (PULSE-POSI) until the point immediately before the rising color of the image after back porch disappears.

Note: If image phase adjustment or HV DELAY amount adjustment during HV DELAY is performed after completing the adjustment in this section, re-adjustments will be required. Therefore, performed this adjustment after the two mentioned have been performed.

5-3. S BOARD ADJUSTMENTS

—S BOARD (COMPONENT SIDE)—

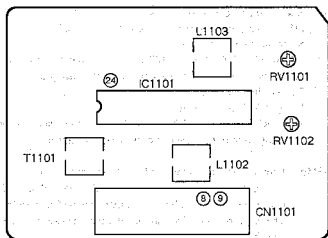

DEMODULATION LEVEL ADJUSTMENT (RV1101, RV1102)

1. Receive SECAM color-bar.
2. Connect an oscilloscope to IC124 pin-Ⓢ (B-OUT).
3. Adjust S board RV1101 (SEC-COL) so that waveform peaks should have the same level (most flat).

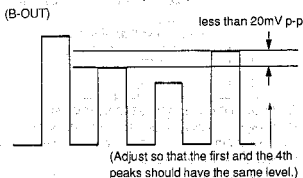

SECAM (T1101, L1102, L1103)

1. Receive SECAM color-bar.
2. Bell Filter Adjustment (T1101)
- (1) Connect an oscilloscope to IC1101 pin-Ⓢ.
- (2) Adjust T1101 (Bell Filter) so that the chroma waveform becomes smooth. (Uneven level should be minimum.)

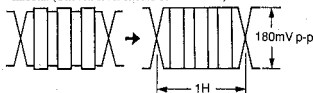

3. Color Balance Adjustment (L1102, L1103)
- (1) Connect an oscilloscope to pin-Ⓢ (R-Y) of CN1101 connector.
- (2) Adjust L1102 (R-Y) so that the non-colored portion level becomes flat.



- (3) Connect an oscilloscope to pin-Ⓢ (B-Y) of CN1101 connector.
- (4) Adjust L1103 (B-Y) so that the non-colored portion level becomes flat.



- (5) When adjusting the color level of the unit to MAX or MIN using the chroma adjusting knob, check that the white balance of the colorless section does not change.

4. Connect an oscilloscope to IC124 pin-Ⓢ (R-OUT).
5. Adjust S board RV1102 (SEC-COL (R-Y)) so that the level difference should be minimum.

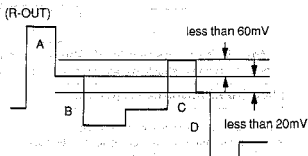

(Adjust for B=D. [less than 20mV] Also level difference between B and C should be less than 60mV.)

SECTION 6
DIAGRAMS

6-1. FRAME SCHEMATIC DIAGRAM

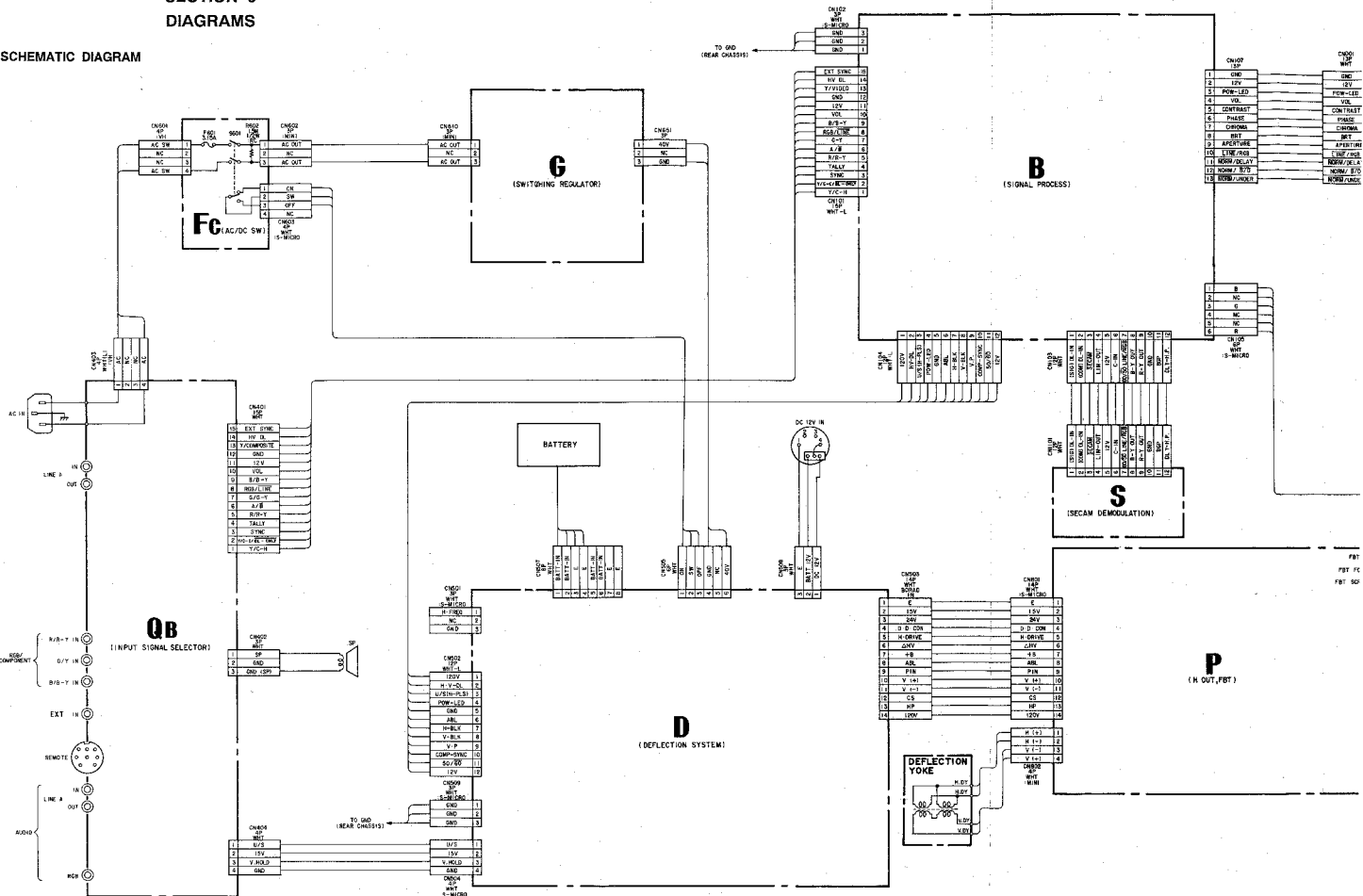

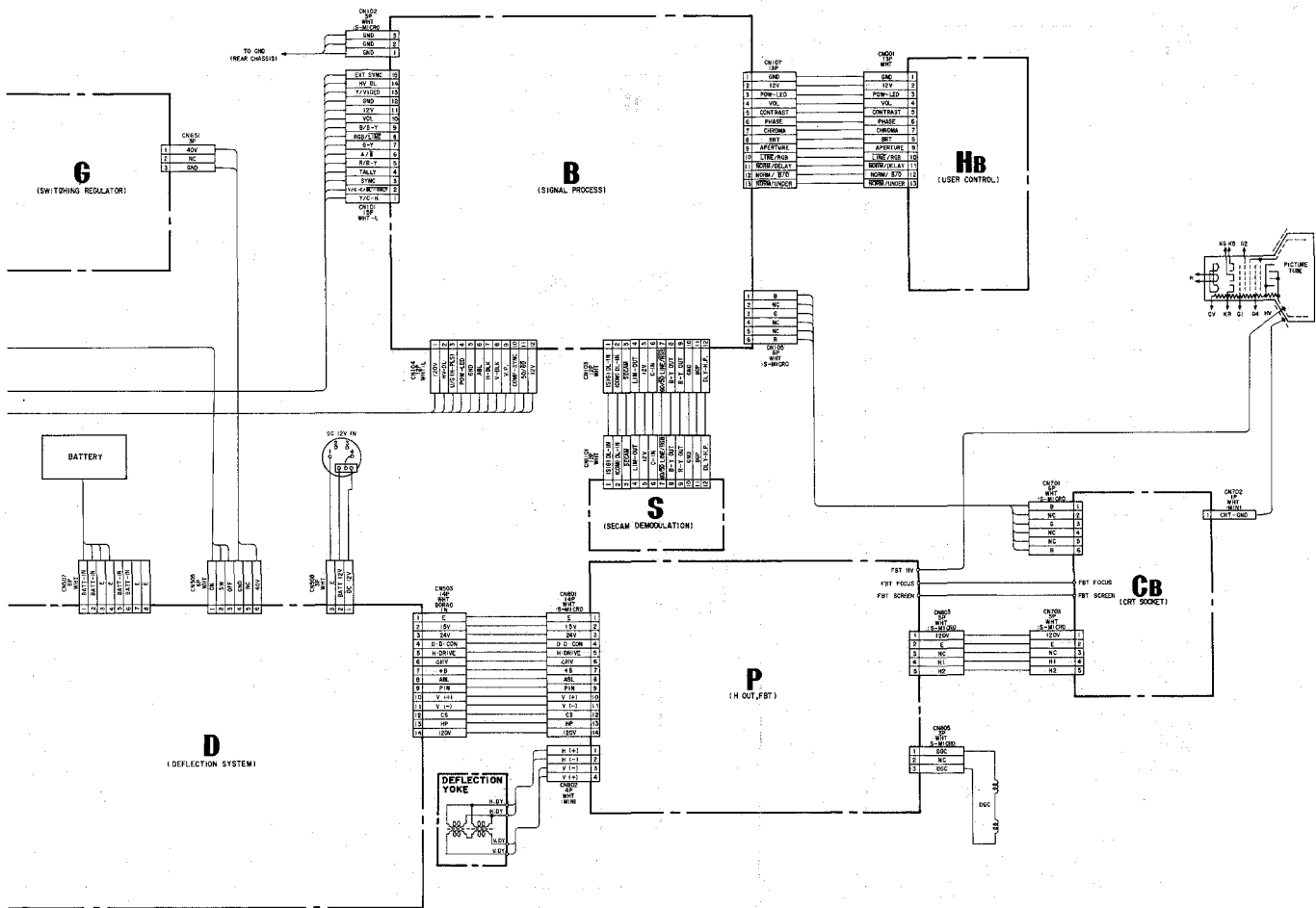

6-2. BLOCK DIAGRAM (1)

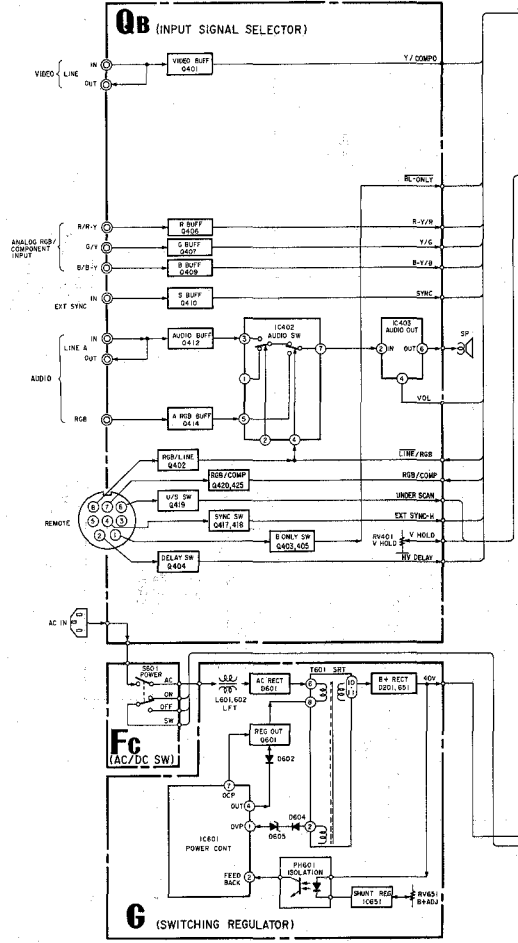

Fc
(AC/DC SW)

G
(SWITCHING REGULATOR)

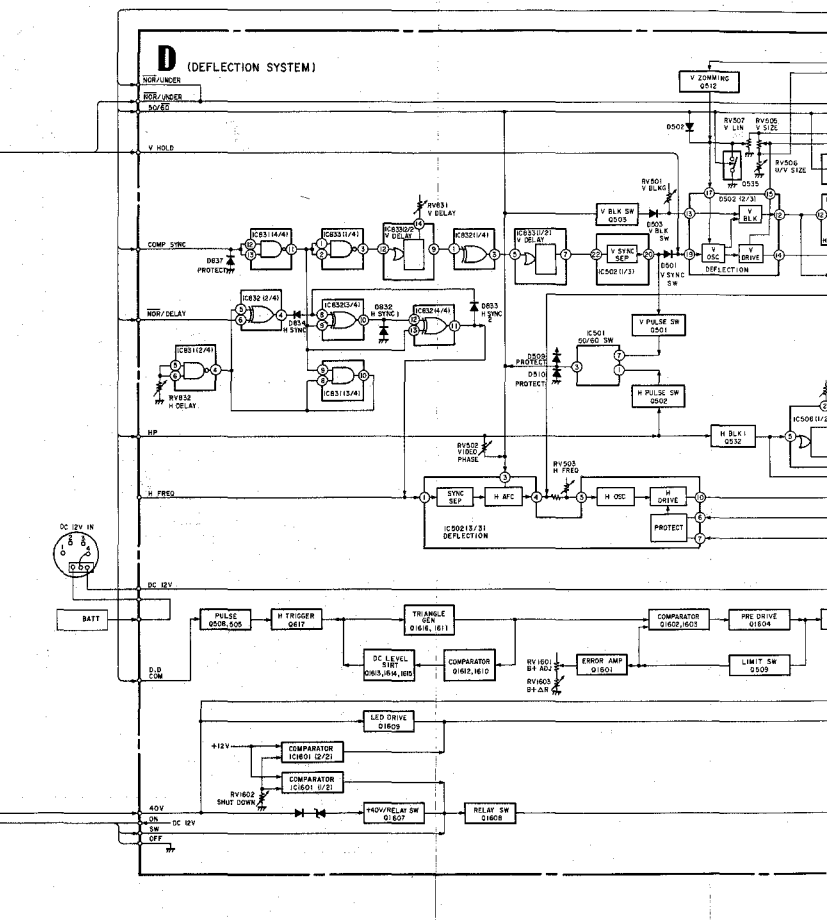

A TO BOARD

D (DEFLECTION SYSTEM)

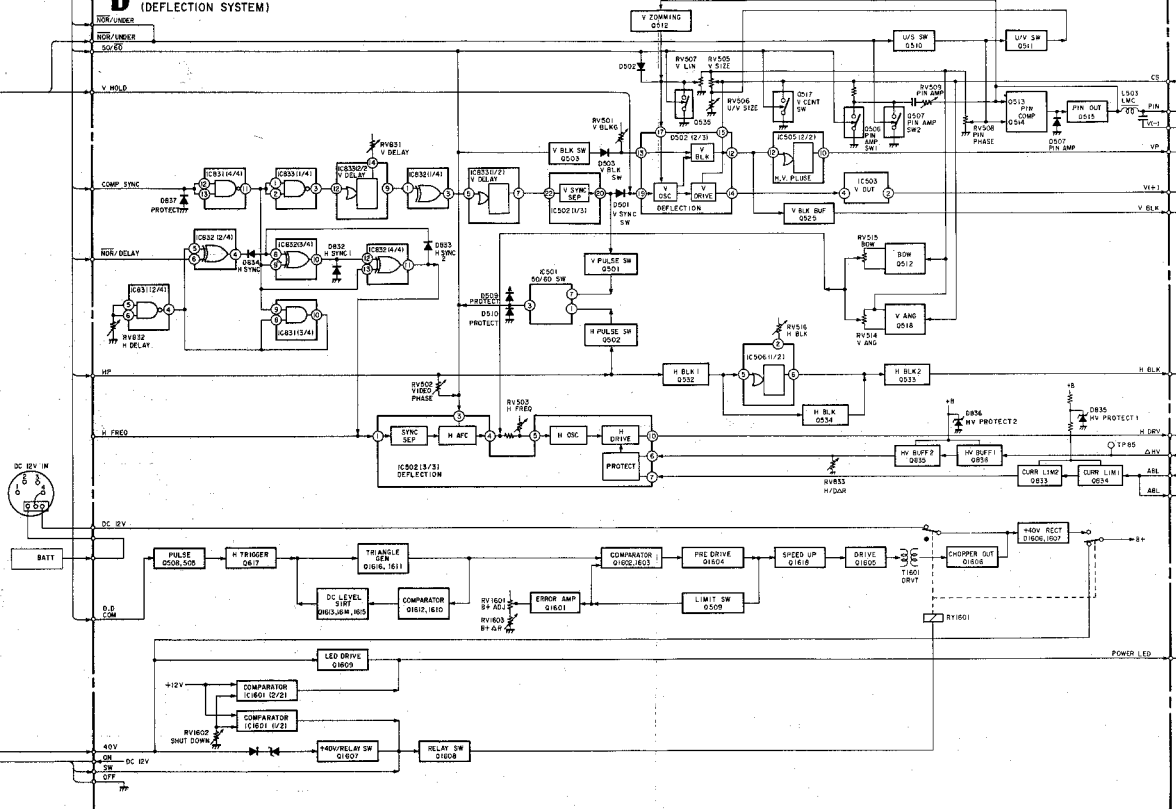

B TO BOARD

C TO BOARD

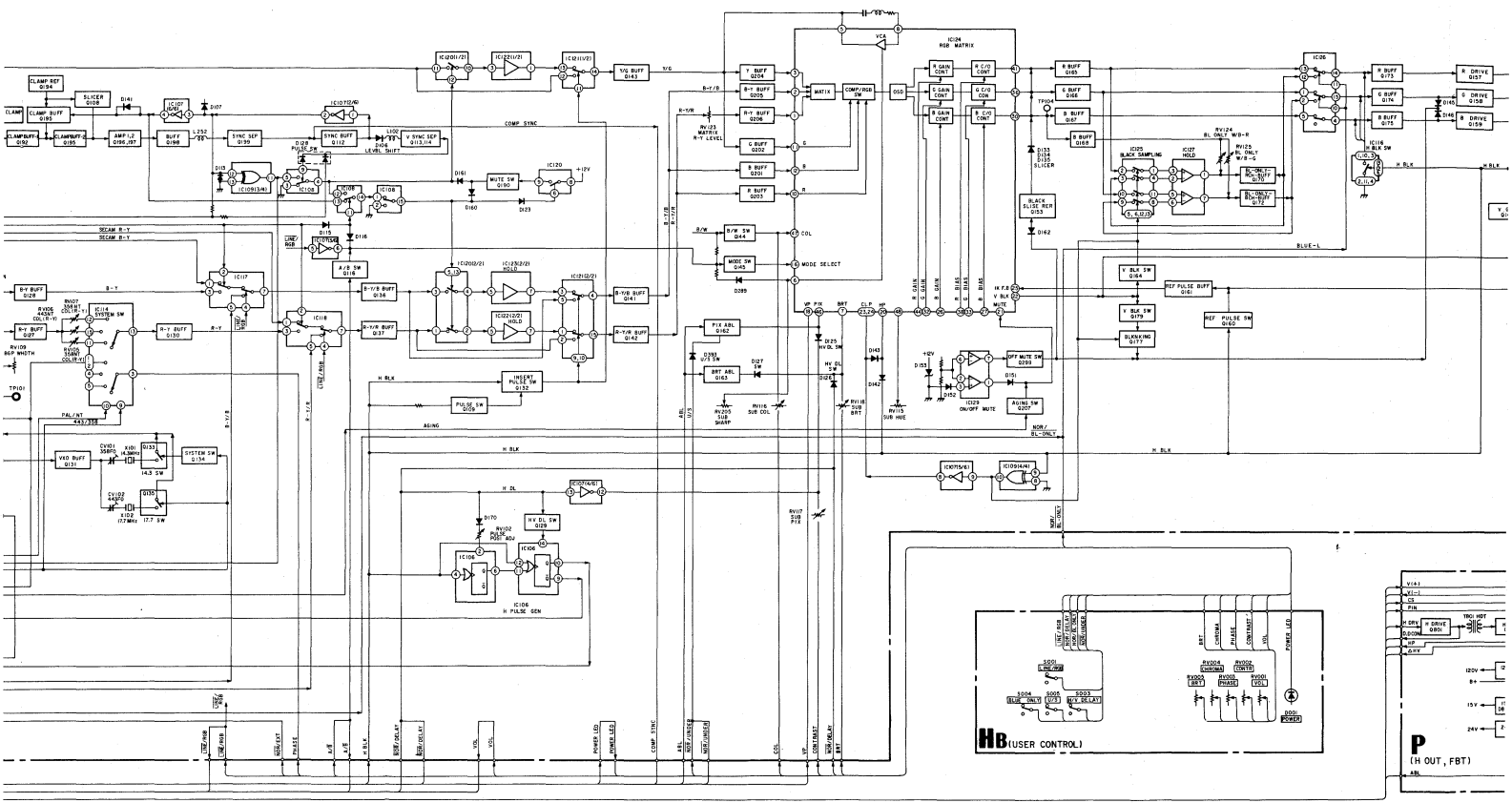

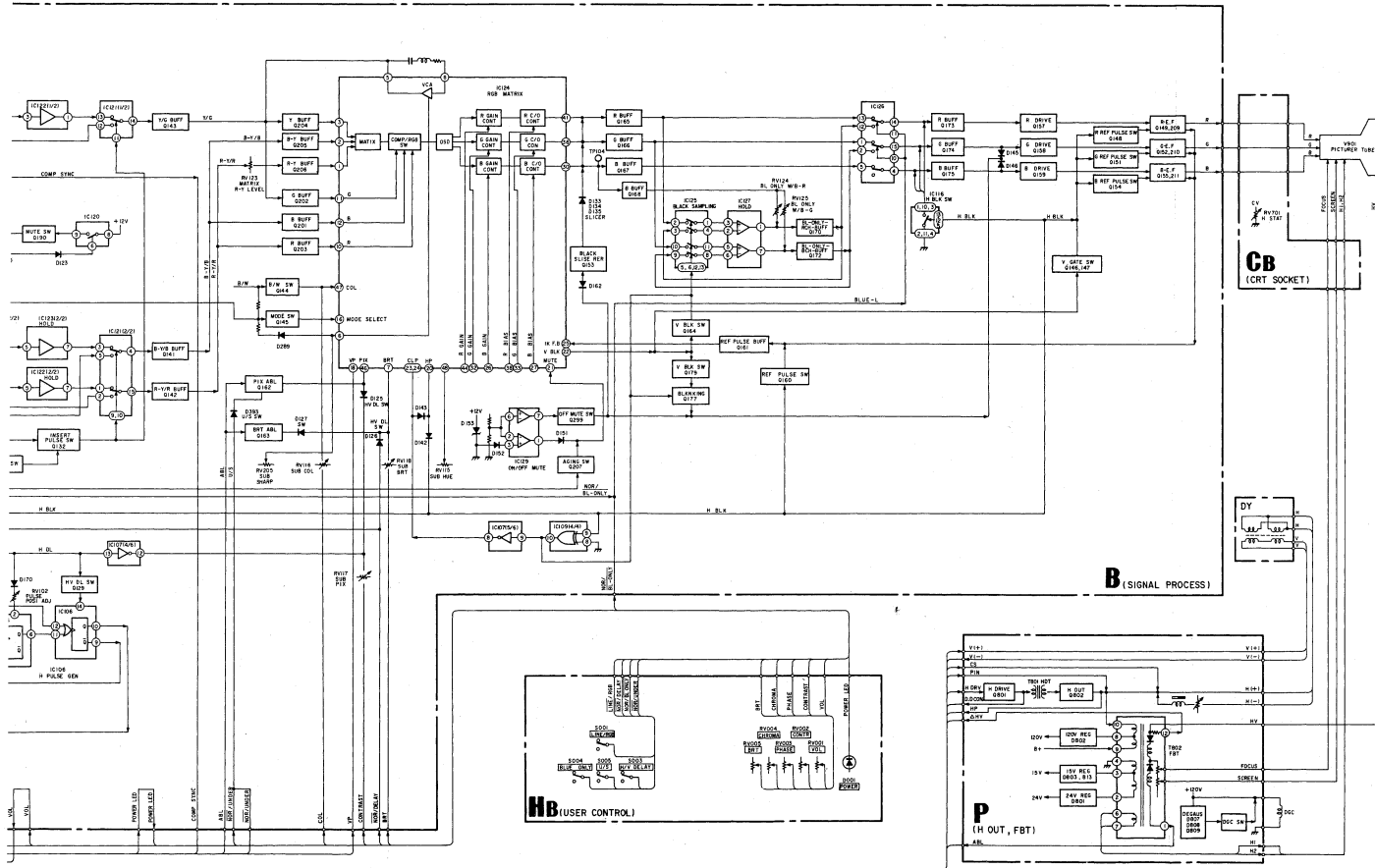

6-4. CIRCUIT BOARDS LOCATION

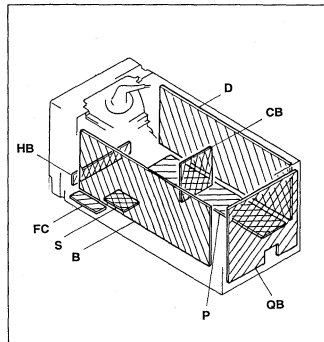

6-5. PRINTED WIRING BOARDS AND SCHEMATIC DIAGRAMS

Note:

- All capacitors are in μF unless otherwise noted. pF: μF 50 WV or less are not indicated except for electrolytics.
- Indication of resistance, which does not have one for rating electrical power, is as follows.

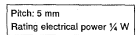

- All resistors are in ohms.
- $\frac{1}{2}$: nonflammable resistor.
- $\frac{1}{2}$: fusible resistor.
- $\frac{1}{2}$: internal component.
- Δ : panel designation.
- All variable and adjustable resistors have characteristic curve B, unless otherwise noted.
- The components identified by \square in this basic schematic diagram have been carefully factory-selected for each set in order to satisfy regulations regarding X-ray radiation. Should replacement be required, replace only with the value originally used.
- When replacing components identified by \square , make the necessary adjustments indicated. If results do not meet the specified value, change the component identified by \square and repeat the adjustment until the specified value is achieved. (Refer to RV651, RV1603, and RV833 adjust on page 18 and 19.)
- When replacing the part in below table be sure to perform the related adjustment.

Part replaced (\square)	Adjustment (\square)
IC601, IC651, PH602, C654, R653, R655, R656, R657, RV651	RV651 (B+ MAX)
G1601, G1602, Q1603, D1601, D1602, D1603, D1604, D1605, C1601, C1602, R1601, R1602, R1603, R1604, R1605, R1606, R1607, R1608, R1628, R1629, R1630, RV1601, RV1603	RV1603 (B+ MAX IN DC POWER INPUT MODE)
IC832, C833, C834, C835, C836, D835, D836, C819, C814, C843, C844, C845, C846, C847, C848, RV833, R823, R850, R851, R852, R853, R854, R855, R856, R857, R858, R859, R861, R862, R863, NL801	R833 (HOLD-DOWN)

- All voltages are in V.
- Voltage are dc with respect to ground unless otherwise noted.
- Readings are taken with a color-bar signal input.
- Readings are taken with a PAL color-bar signal input.
- \square : adjustment for repair.
- Voltage variations may be noted due to normal production tolerance.
- --- : B + bus.
- --- : B - bus.
- --- : signal path.
- No mark: with PAL color-bar signal received or common voltage.
- (\square): with SECAM color-bar signal received.
- < \square): with NTSC 3.58 color-bar signal received.
- (\square): with NTSC 4.43 color-bar signal received.
- [\square]: with S(Y/C) color-bar signal received.
- [\square]: with analog RGB color-bar signal received.
- < \square >: with component color-bar signal received.
- --- : measurement impossibility

- Reference information**
- RESISTOR**
- RN METAL FILM
 - RC SOLID
 - FPFD NONFLAMMABLE CARBON
 - FUSE NONFLAMMABLE FUSIBLE
 - RS NONFLAMMABLE WIREWOUND
 - RB NONFLAMMABLE CEMENT
 - LF-8L MICRO INDUCTOR
- COIL**
- CAPACITOR**
- TA TANTALUM
 - PS STYROL
 - PP POLYPROPYLENE
 - PT MYLAR
 - MPS METALIZED POLYESTER
 - MPP METALIZED POLYPROPYLENE
 - ALB BIPOLAR
 - ALT HIGH TEMPERATURE
 - ALR HIGH RIPPLE

P [H OUT, FB] **G** [SWITCHING REGULATOR] **S** [SECAM DEMODULATION] **FC** [AC/DC SWITCH] **HB** [USER CONT]

- P Board -

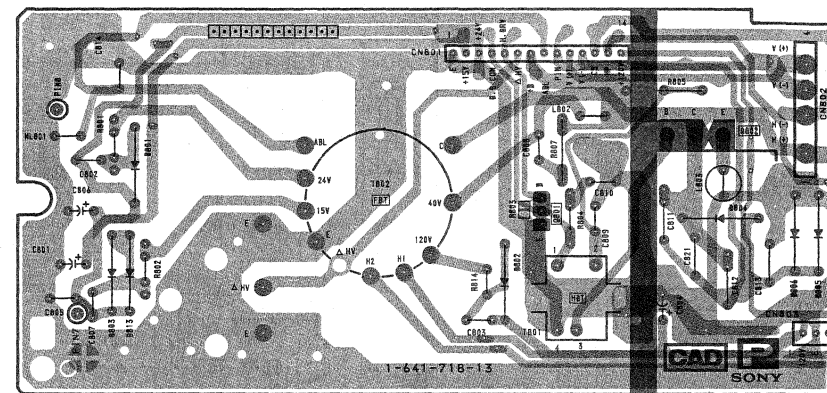

- G Board -

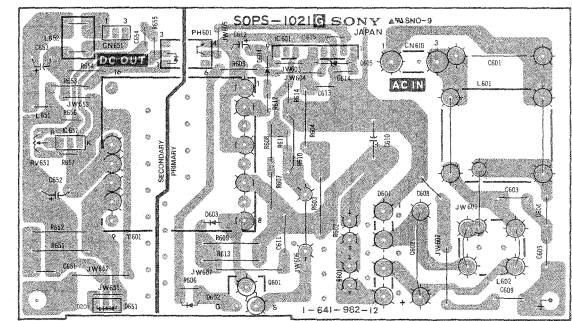

- FC Board -

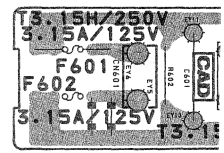

ECAM DEMODULATION] **Fc** [AC/DC SWITCH] **Hb** [USER CONTROL]

Qb [INPUT SIGNAL SE]

- S Board - Conductor Side -

- S Board - Component Side -

- QB Board -

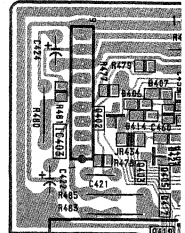
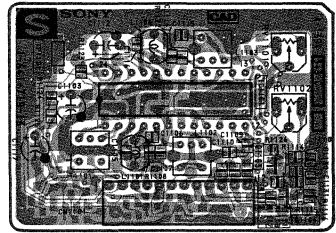
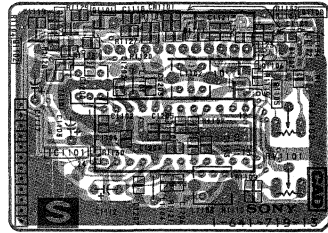
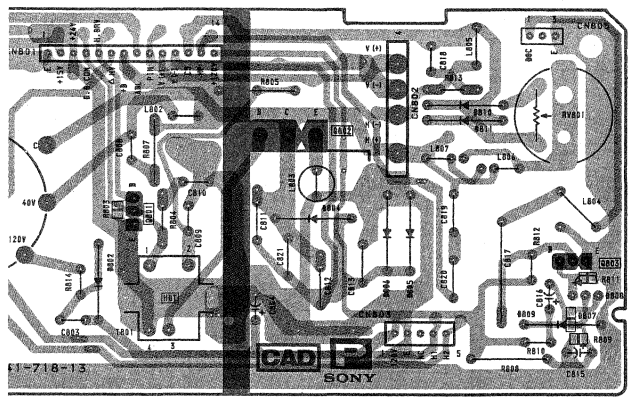

- FC Board -

- HB Board -

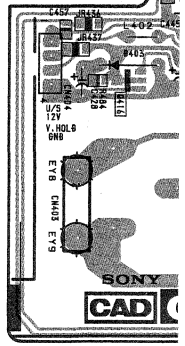
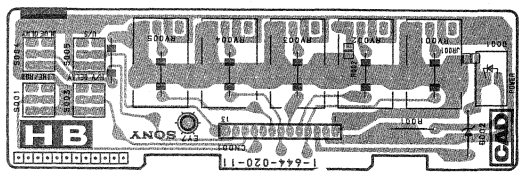
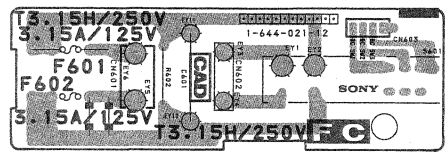
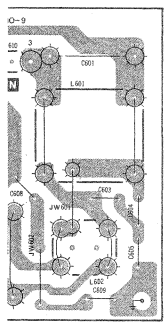

QB

[INPUT SIGNAL SELECTOR]

- S Board - Conductor Side -

- S Board - Component Side -

- QB Board -

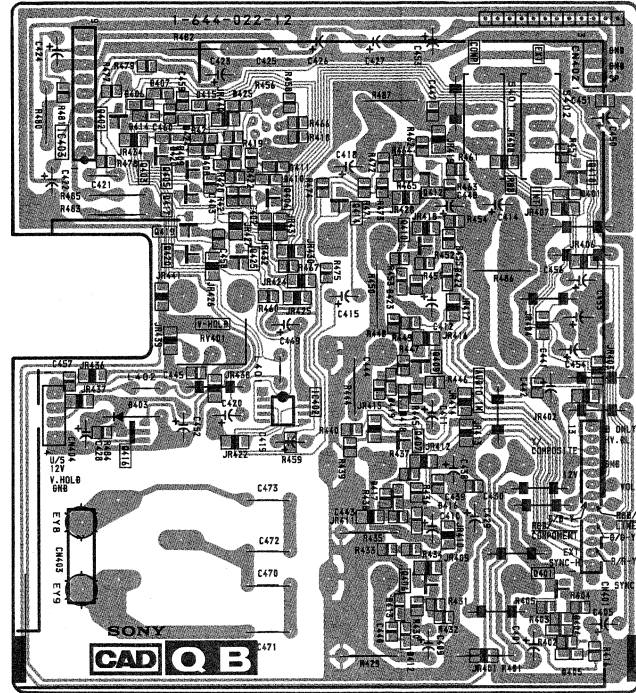
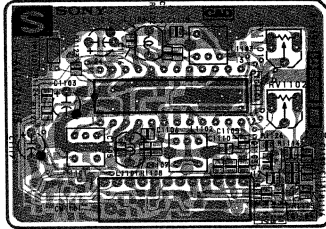
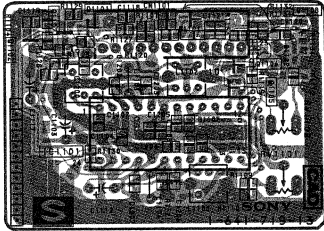

- HB Board -

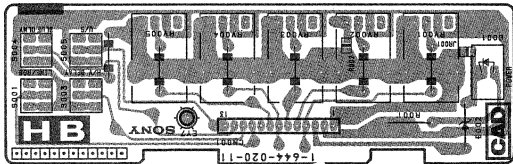

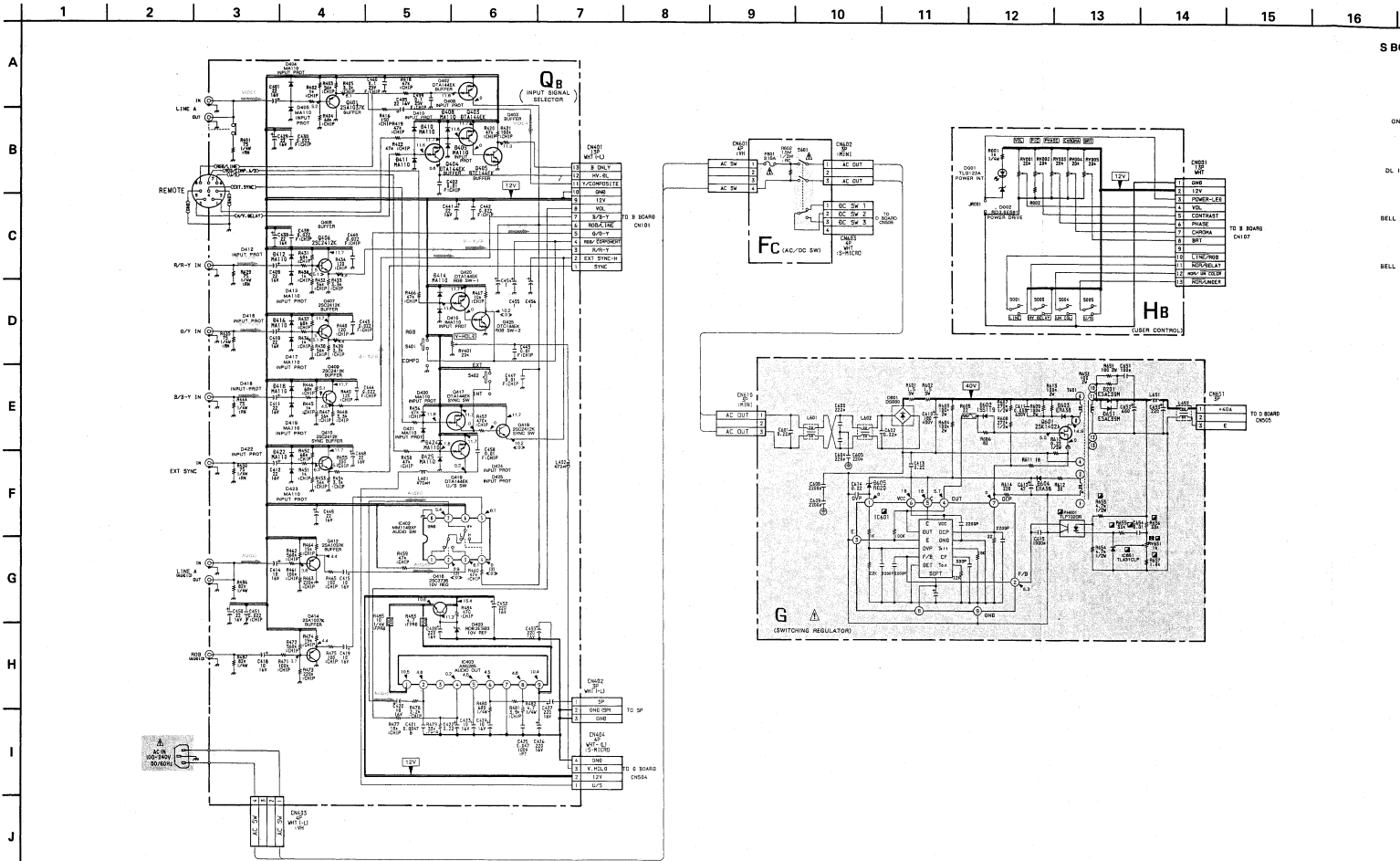

15 16 17 18 19 20 21 22 23 24 25 26 27 28 29 30

S BOARD IC1101 CXA1214P

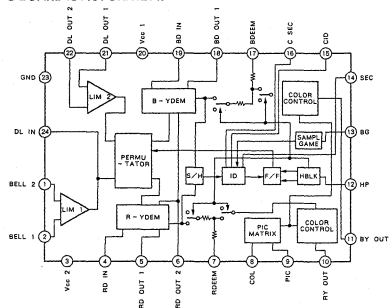

QB BOARD IC403 AN5265

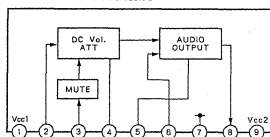

P BOARD WAVEFORMS

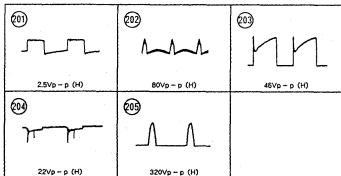

S BOARD WAVEFORMS

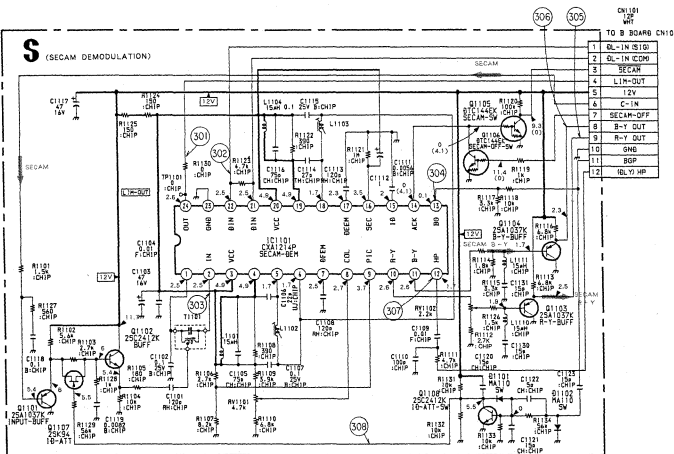
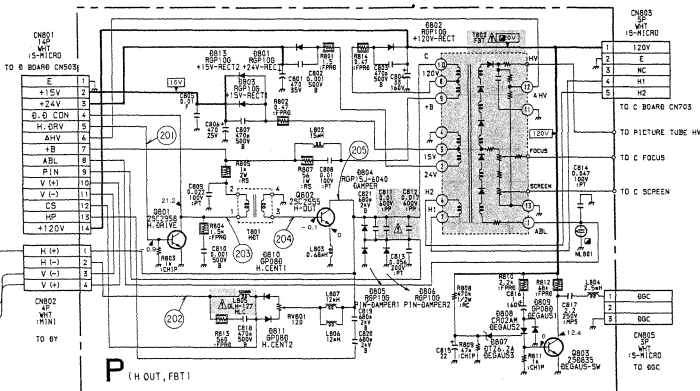
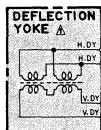
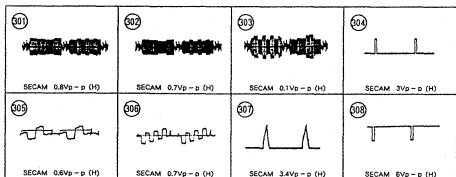

• D BOARD WAVEFORMS

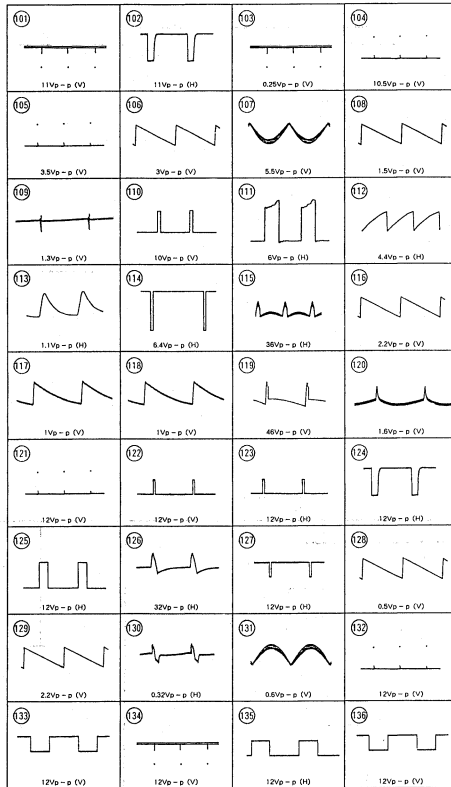

1.2V	2
50ns	2
TRIG	1
SW	1
1.2V	2
50ns	2
TRIG	1
SW	1
1.2V	2
50ns	2
TRIG	1
SW	1
1.2V	2
50ns	2
TRIG	1
SW	1

TO D BOARD (104)

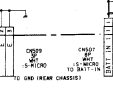
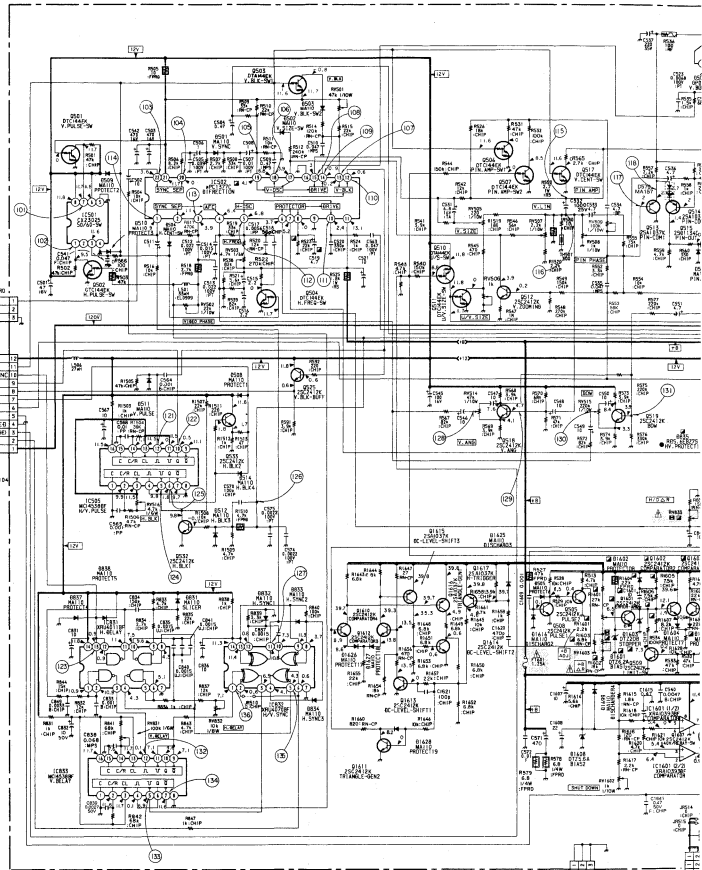

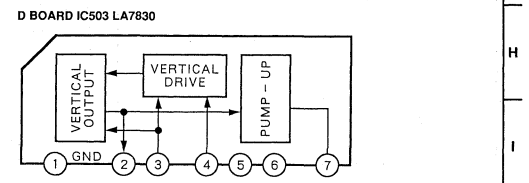
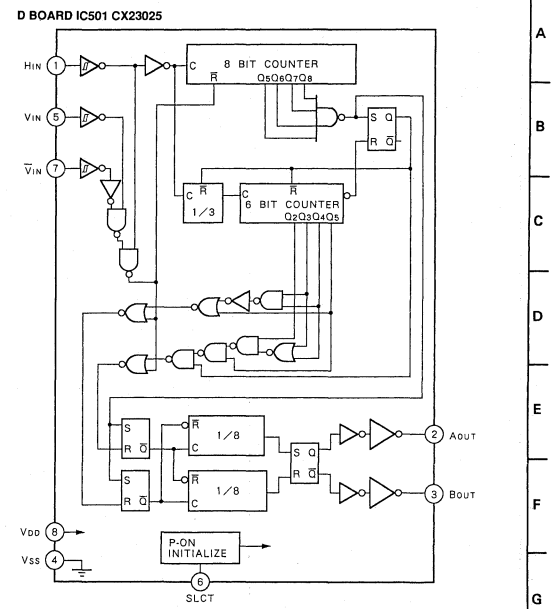
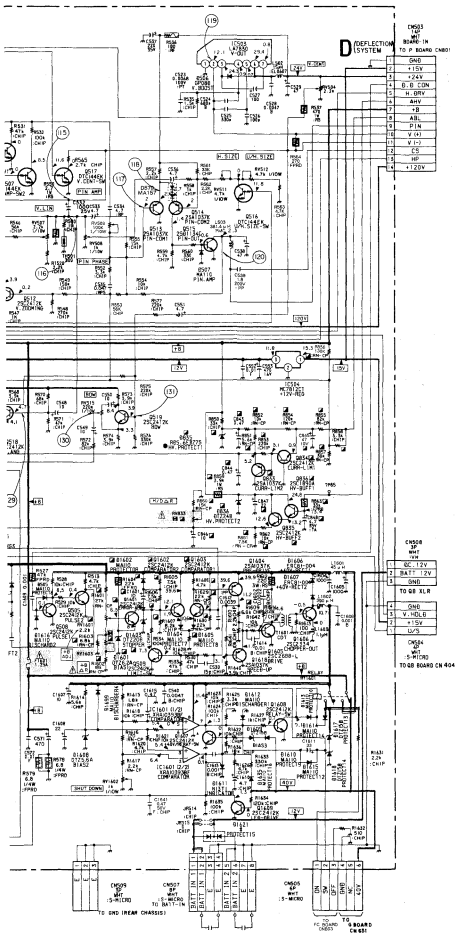

A
B
C
D
E
F
G
H
I
J

D [DEFLECTION SYSTEM]

- D Board - Component Side -

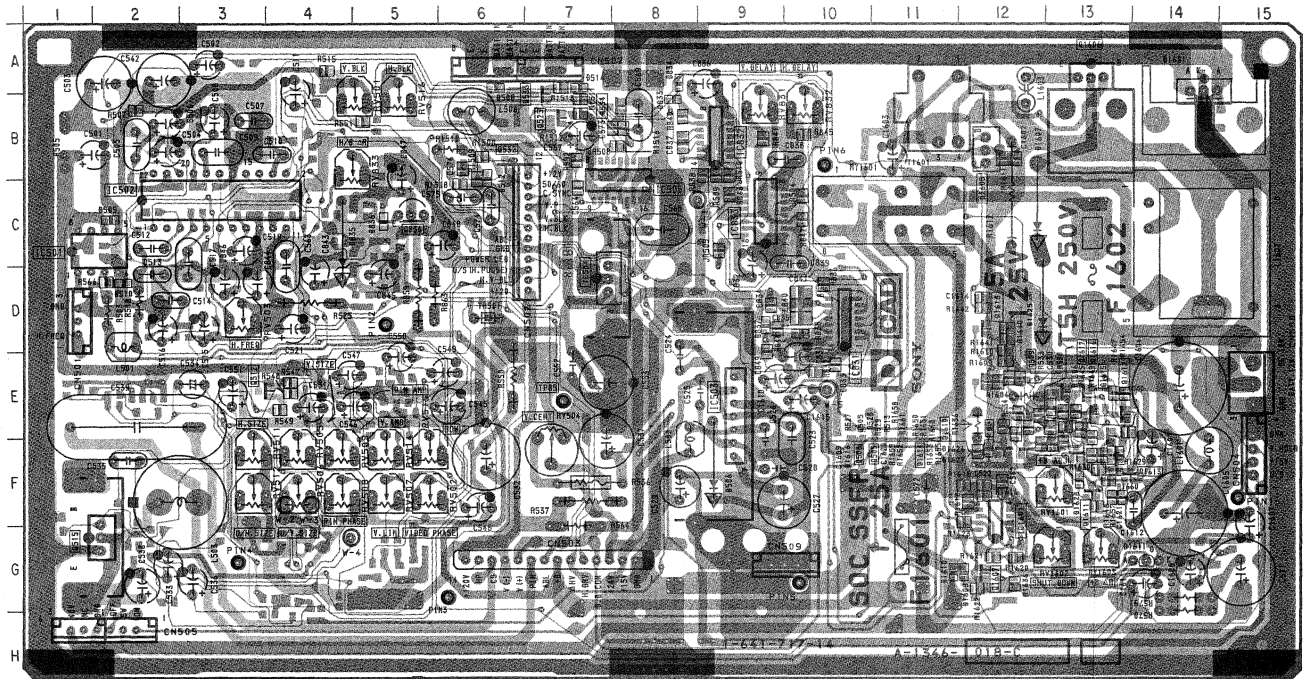

D Board (Component Side)

IC

IC505	C-8
IC531	D-10
IC532	B-9
IC533	C-9
IC701	F-12

TRANSISTOR

Q505	F-12
Q509	F-12
Q509	E-12
Q512	E-4
Q525	B-7
Q535	B-8
Q533	A-7
Q1607	G-12
Q1610	E-13
Q1611	F-13
Q1612	E-13
Q1613	F-14
Q1614	F-13
Q1615	E-13
Q1616	E-13
Q1617	E-13
Q1618	D-12

DIODE

D505	E-12
D509	A-6
D509	C-2
D510	D-2
D514	A-7
D833	B-8
D834	A-8
D835	C-5
D837	D-9
D838	D-10
D1606	E-13
D1609	G-12
D1610	G-11
D1611	G-14
D1616	F-10
D1625	D-12
D1625	F-13
D1627	F-13
D1628	F-13

D Board (Component Side)

IC	
IC505	C-8
IC831	D-10
IC832	B-9
IC833	C-5
IC1601	F-12
TRANSISTOR	
Q505	F-12
Q508	F-12
Q509	E-12
Q512	E-4
Q525	B-7
Q535	B-6
Q533	A-7
Q1607	G-12
Q1610	E-13
Q1611	F-13
Q1612	E-13
Q1613	F-14
Q1614	F-13
Q1615	E-13
Q1616	E-13
Q1617	E-13
Q1618	D-12
DIODE	
D505	E-12
D508	A-6
D509	C-2
D510	D-2
D514	A-7
D633	B-8
D634	A-8
D636	C-5
D637	B-9
D638	D-10
D1606	E-13
D1609	G-12
D1610	G-11
D1611	G-14
D1616	F-10
D1625	D-12
D1626	F-13
D1628	F-13

- D Board - Conductor Side -

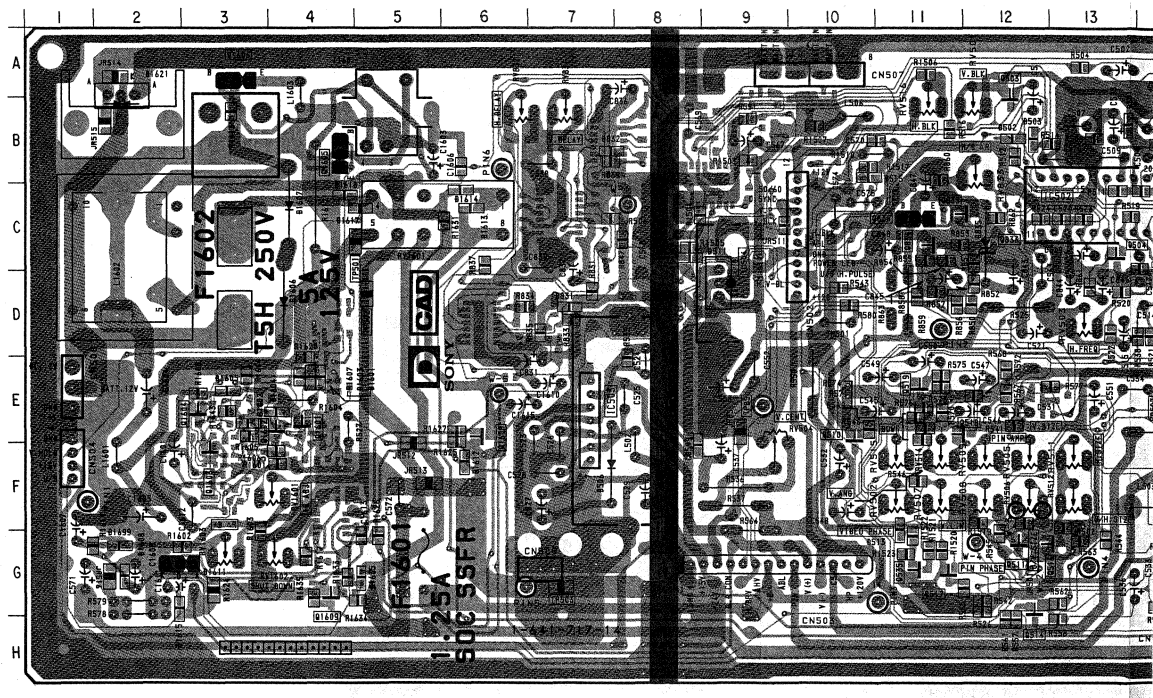

PROCESS]

- Component Side -

2 3 4 5 6 7 8 9 10 11 12 13 14 15

B Board (Component Side)

IC	Q176	F-9
	Q191	B-2
IC102	Q193	B-1
IC103	Q196	B-2
IC104	Q197	B-2
IC105	Q198	A-3
IC106	G200	F-8
IC107	G204	B-9
IC108	G205	A-9
IC109	G206	A-8
IC110	G208	B-3
IC111	E-11	G212 C-11
IC112	G-13	G289 A-11
IC113	G-14	
IC114	G-12	
IC115	E-14	
IC116	D-11	
IC117	F-6	D107 D-2
IC118	F-5	D118 C-1
IC119	F-4	D119 C-1
IC120	C-4	D121 E-4
IC121	C-5	D122 D-4
IC122	D-5	D123 C-4
IC123	D-4	D128 E-1
IC124	C-10	D130 B-13
IC125	C-12	D131 C-14
IC126	C-12	D132 D-14
IC127	B-12	D137 G-11
IC128	E-13	D138 D-13
IC129	B-4	D139 C-13
	D142	C-9
	D143	C-9
	D146	D-12
TRANSISTOR	D151	C-5
Q101	F-6	D152 B-4
Q104	G-10	D153 B-4
Q109	A-12	D154 B-13
Q115	C-1	D156 C-13
Q119	F-12	D157 A-13
Q121	E-12	D162 B-11
Q124	F-11	D342 D-12
Q129	C-3	D343 H-2
Q132	C-5	D344 F-8
Q136	F-6	D345 A-14
Q137	F-5	D346 B-14
Q138	F-5	D346 B-14
Q141	C-6	D347 C-14
Q150	G-8	D348 B-14
Q164	B-12	D349 C-14
Q166	D-12	D350 D-14
Q171	F-8	D393 F-3

- B Boa

A
B
C
D
E
F
G
H

- B Board - Conductor Side -

ent Side)

- 6 F-9
- 5 B-2
- 3 B-11
- 6 B-2
- 7 B-2
- 2 A-3
- 0 F-8
- 4 B-9
- 5 A-9
- 6 A-9
- 8 B-3
- 2 C-11
- 9 A-11

DIODE

- 7 D-2
- 4 C-1
- 8 C-1
- 9 C-1
- 1 E-4
- 2 D-4
- 3 C-4
- 8 E-1
- 0 B-13
- 1 C-14
- 2 D-14
- 7 G-11
- 8 D-13
- 9 C-13
- 2 C-9
- 3 C-9
- 5 D-12
- 1 C-5
- 2 B-4
- 3 B-4
- 4 B-13
- 5 C-13
- 7 A-13
- 2 B-11
- 2 D-12
- 1 H-2
- 4 F-8
- 5 A-14
- 3 B-14
- 7 C-14
- 3 B-14
- 3 C-14
- 3 C-14
- 3 F-3

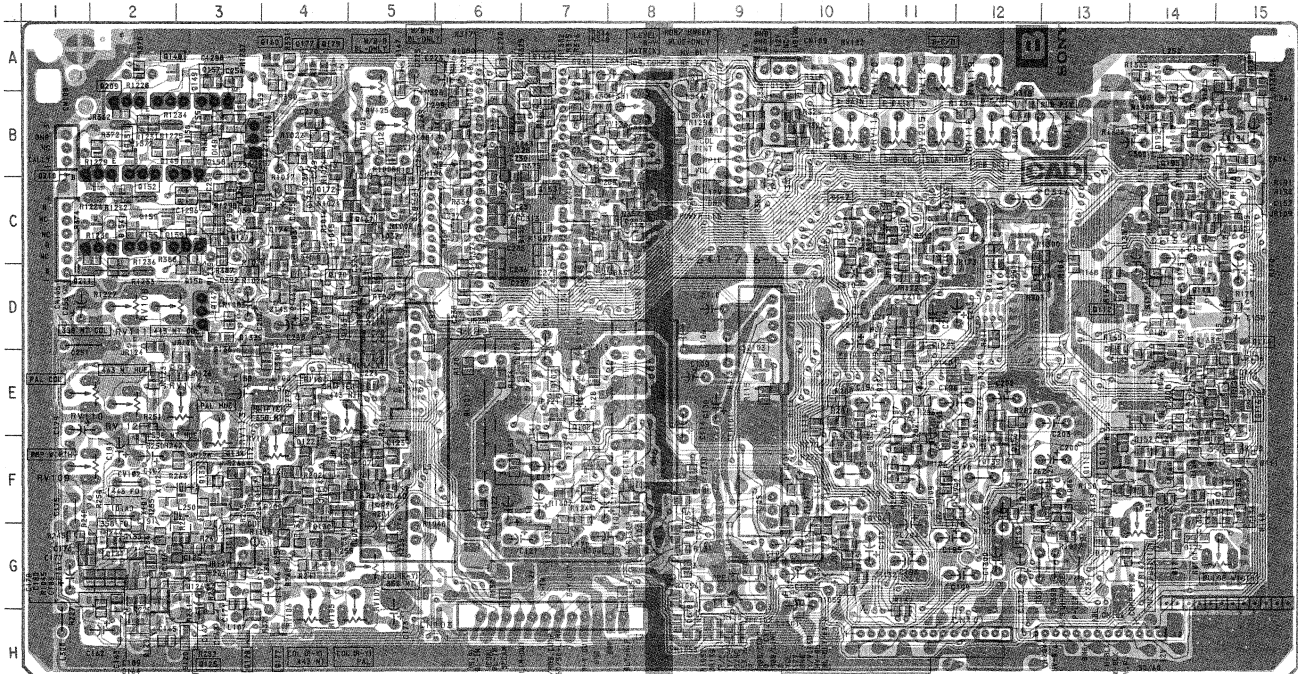

B Board (Co

TRANSISTOR

- 0102 G-12
- 0103 E-8
- 0106 F-10
- 0107 E-7
- 0108 E-7
- 0112 D-14
- 0113 D-14
- 0114 D-15
- 0116 E-15
- 0117 F-4
- 0118 E-4
- 0120 F-4
- 0122 F-4
- 0123 F-5
- 0125 G-2
- 0126 G-3
- 0127 H-4
- 0128 H-3
- 0130 G-4
- 0131 G-2
- 0133 G-2
- 0134 F-3
- 0135 F-3
- 0138 F-12
- 0140 E-11
- 0142 C-10
- 0143 C-11
- 0144 A-7
- 0145 C-7
- 0146 B-3
- 0147 D-3
- 0148 A-3
- 0149 B-2
- 0151 B-2
- 0152 B-2
- 0153 C-6
- 0154 C-2
- 0155 C-2
- 0157 B-3
- 0158 B-3
- 0159 C-3
- 0160 A-4
- 0161 C-3
- 0162 G-12
- 0163 F-12
- 0165 D-4
- 0167 C-5
- 0168 C-5
- 0170 C-4
- 0172 C-5
- 0173 D-4
- 0174 C-4
- 0175 A-4
- 0177 A-4
- 0179 A-4

uctor Side -

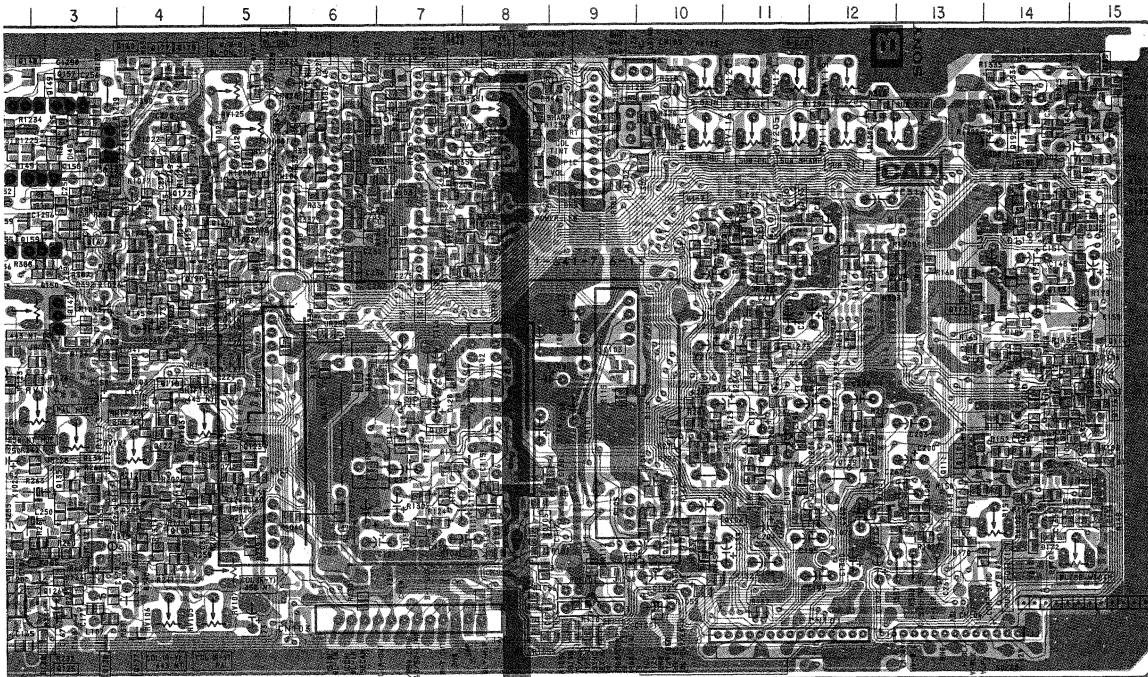

B Board (Conductor Side)

TRANSISTOR	Q180 C-12	VARIABLE RESISTOR
Q102 G-10	Q182 B-8	RV101 G-15
Q103 E-9	Q184 B-15	RV102 F-14
Q106 F-10	Q185 B-14	RV103 E-4
Q107 E-7	Q189 A-15	RV104 F-4
Q108 E-7	Q201 C-7	RV105 H-5
Q112 D-14	Q202 C-8	RV106 H-4
Q113 D-14	Q203 C-8	RV107 G-5
Q114 D-15	Q208 B-2	RV108 D-2
Q116 E-15	Q210 B-2	RV109 F-1
Q117 F-4	Q211 C-2	RV110 E-1
Q118 E-4		RV111 E-2
Q120 F-4		RV112 E-2
Q122 F-4	D101 F-8	RV113 E-3
Q123 F-5	D102 F-8	RV114 E-3
Q125 G-2	D104 F-7	RV115 B-10
Q126 G-3	D105 G-8	RV116 B-11
Q127 H-4	D106 D-14	RV118 B-12
Q128 H-3	D108 E-14	RV119 A-12
Q130 G-4	D109 E-14	RV120 A-11
Q131 G-2	D110 F-14	RV121 A-11
Q133 G-2	D111 F-15	RV122 A-10
Q134 F-3	D112 C-15	RV123 B-8
Q135 F-3	D113 C-14	RV124 B-5
Q139 F-12	D115 E-14	RV125 B-5
Q140 E-11	D116 E-14	RV205 B-11
Q142 C-10	D117 E-14	
Q143 C-11	D120 H-3	
Q144 A-7	D125 B-9	
Q145 C-7	D126 B-10	
Q146 B-3	D127 F-13	
Q147 D-3	D129 H-2	
Q148 A-3	D133 C-6	
Q149 B-2	D134 C-6	
Q151 B-2	D135 C-6	
Q152 B-2	D136 D-3	
Q153 C-6	D144 D-4	
Q154 C-2	D145 D-4	
Q155 C-2	D147 A-5	
Q157 B-3	D148 B-3	
Q158 B-3	D149 B-3	
Q159 C-3	D150 D-2	
Q160 A-4	D155 B-3	
Q161 C-3	D156 B-3	
Q162 G-12	D159 C-2	
Q163 F-12	D160 C-12	
Q165 D-4	D161 C-12	
Q167 C-5	D170 G-13	
Q168 C-5	D171 G-14	
Q170 C-4	D172 G-14	
Q172 C-5	D285 E-1	
Q173 D-4	D289 B-8	
Q174 C-4	D341 B-15	
Q175 C-4		
Q177 A-4		
Q179 A-4		

1 2 3 4 5 6 7 8 9 10 11 12 13 14 15 16

A
B
C
D
E
F
G
H
I
J

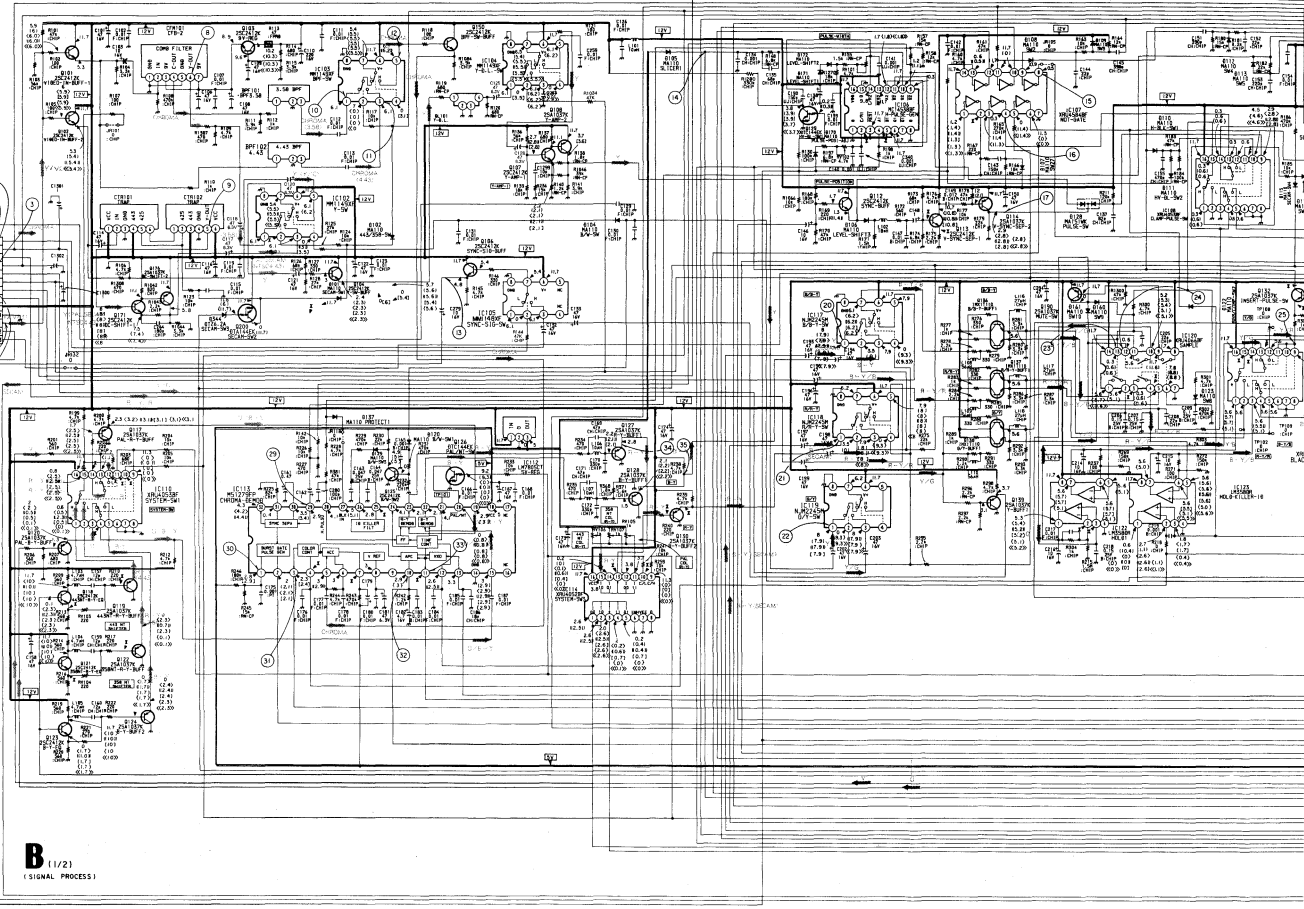
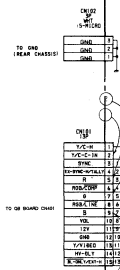

B (1/2)
(SIGNAL PROCESS)

15 16 17 18 19 20 21 22 23 24 25 26 27 28 29 30

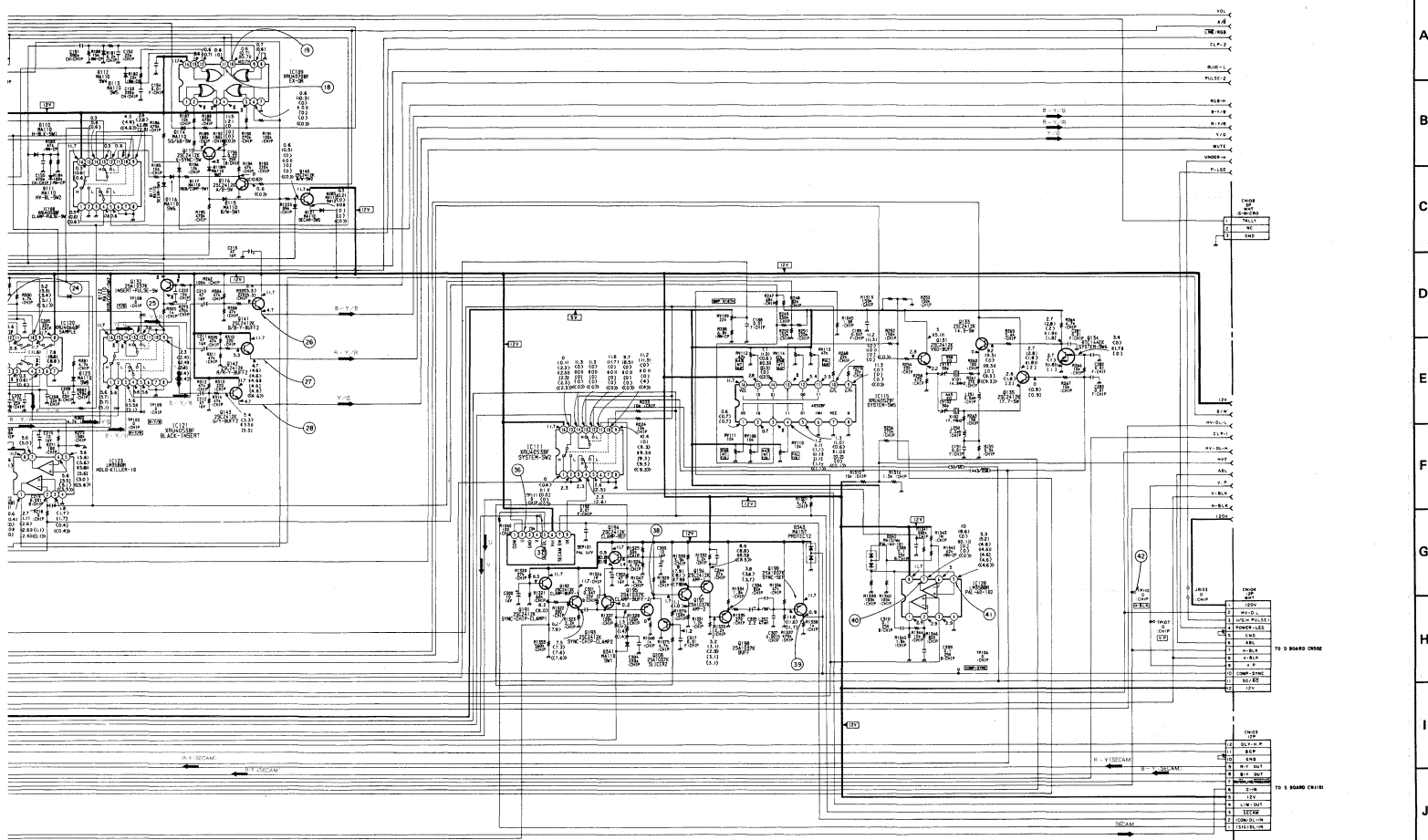

A
B
C
D
E
F
G
H
I
J

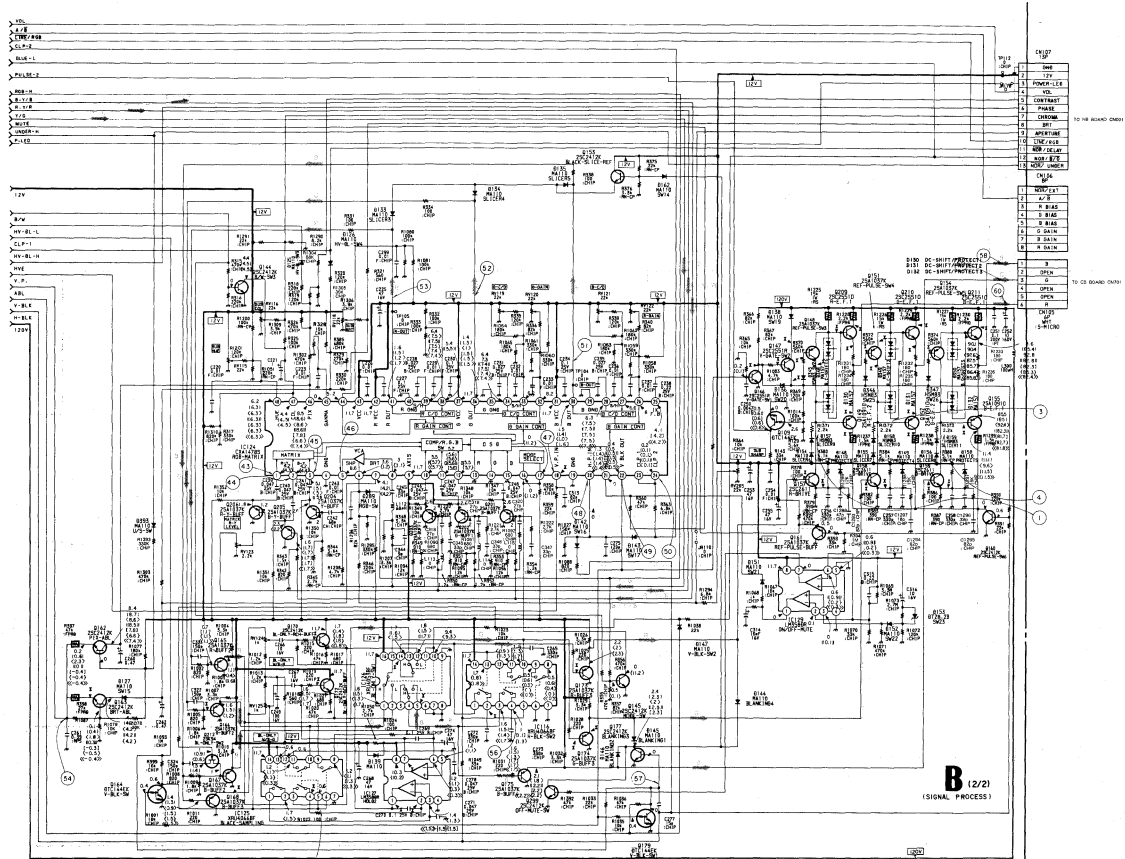

1	TR1
2	TR2
3	TR3
4	TR4
5	TR5
6	TR6
7	TR7
8	TR8
9	TR9
10	TR10
11	TR11
12	TR12
13	TR13
14	TR14
15	TR15

1	TR16
2	TR17
3	TR18
4	TR19
5	TR20
6	TR21
7	TR22
8	TR23
9	TR24
10	TR25
11	TR26
12	TR27
13	TR28
14	TR29
15	TR30

B (2/2)
(SIGNAL PROCESS)

— B I
X

Q110
Q111
Q112
Q113
Q114
Q115
Q116
Q117
Q118
Q119
Q120
Q121
Q122
Q123
Q124
Q125
Q126
Q127
Q128
Q129
Q130
Q131
Q132
Q133
Q134
Q135
Q136
Q137
Q138
Q139
Q140
Q141
Q142
Q143
Q144
Q145
Q146
Q147
Q148
Q149
Q150
Q151
Q152
Q153
Q154
Q155
Q156
Q157
Q158
Q159
Q160
Q161
Q162
Q163
Q164
Q165
Q166
Q167
Q168
Q169
Q170
Q171
Q172
Q173
Q174
Q175
Q176
Q177
Q178
Q179
Q180
Q181
Q182
Q183
Q184
Q185
Q186
Q187
Q188
Q189
Q190
Q191
Q192
Q193
Q194
Q195
Q196
Q197
Q198
Q199
Q200
Q201
Q202
Q203
Q204
Q205
Q206
Q207
Q208
Q209
Q210
Q211
Q212

- B Board -

< TRANSISTOR >									
X		PAL	NTSC	NTSC	ANALOG	COMPO			
		SECAM	3.58	4.43	8 (V/C)	ROB	ROB	MENT	
Q113	E	0.5	0.5	0.4	0.4	0.5	0.5	0.5	
B	1.0	1.0	0.9	0.9	0.9	0.9	1.0		
Q115	E	11.2	9.3	0.9	10.8	0.0	5.0	0.0	
B	2.8	2.2	0.1	2.4	0.1	0.1	0.0		
Q118	E	0.0	0.0	1.7	1.7	1.7	1.7	1.7	
Q119	B	0.1	0.0	1.7	1.7	1.7	1.7	1.7	
Q121	E	0.0	0.0	1.7	1.7	1.7	1.7	1.7	
Q122	B	0.0	0.0	1.7	1.7	1.7	1.7	1.7	
Q130	E	4.3	4.3	4.4	4.4	4.5	4.4	4.4	
B	3.7	3.7	3.8	3.8	3.9	3.8	3.8		
Q132	E	2.3	2.3	2.4	2.3	2.4	2.4	2.4	
B	1.8	1.7	1.7	1.7	1.7	1.8	1.8		
B	2.7	2.6	2.8	2.7	2.8	2.7	2.8		
Q149	C	119.7	114.4	110.4	113.2	119.7	116.3	114.1	
Q147	E	117.9	115.9	111.9	114.5	119.0	116.5	115.4	
C	126.0	123.5	120.3	123.4	123.8	124.9	124.4		
B	116.8	119.5	110.5	116.4	116.2	114.2	114.2		
Q148	C	86.1	84.9	81.2	83.4	82.8	82.5	82.2	
B	84.0	83.3	89.3	82.4	82.1	84.2	80.8		
Q149	E	1.0	1.0	1.4	1.7	1.7	1.7	1.7	
C	86.1	84.9	81.2	83.4	82.7	82.5	82.5		
Q151	E	90.7	91.4	86.0	87.9	87.0	86.5	86.4	
C	89.2	89.9	89.5	86.4	85.3	84.9	84.7		
B	92.1	92.7	100.2	89.5	92.4	90.5	88.9		
Q152	E	86.1	86.0	82.8	82.8	82.9	82.8	82.7	
C	10.8	10.5	9.7	10.9	10.9	10.9	11.0		
Q154	B	92.5	92.9	99.9	90.1	88.7	90.4	89.2	
Q155	B	88.3	88.5	95.7	85.7	83.9	84.8	83.9	
Q157	E	82.4	81.1	87.5	79.9	79.9	80.8	79.4	
B	89.0	84.6	91.2	84.4	82.7	82.5	82.1		
Q158	E	1.0	1.0	1.9	1.8	1.8	1.7	1.7	
B	2.1	2.0	1.8	2.1	2.2	2.2	2.2		
Q159	E	1.8	1.8	1.3	1.8	1.7	1.7	1.7	
B	2.2	2.1	1.5	2.1	2.2	2.2	2.2		
Q163	E	0.2	0.8	2.7	0.5	-0.5	-0.7	-0.9	
Q168	B	0.8	0.9	0.8	1.0	1.0	1.0	1.0	
Q169	C	2.1	2.0	1.8	2.1	2.2	2.1	2.2	
Q170	B	2.3	2.3	2.1	2.4	2.4	2.4	2.4	
Q172	B	2.2	2.1	1.9	2.2	2.3	2.2	2.3	
Q173	B	1.7	1.6	1.4	1.7	1.7	1.7	1.7	
Q174	E	2.1	2.0	1.8	2.1	2.2	2.2	2.2	
B	1.8	1.5	1.3	1.8	1.8	1.7	1.7		
Q178	B	6.2	6.3	6.2	6.3	6.1	6.2	6.2	
Q209	E	83.4	81.5	87.9	80.3	80.4	80.4	79.8	
C	115.8	113.2	110.7	113.2	113.8	114.5	114.2		
B	87.8	86.4	82.8	82.0	84.3	84.2	83.8		
Q210	E	86.5	86.3	93.1	83.0	83.3	83.0	82.9	
C	116.5	114.2	111.5	113.9	114.5	115.1	114.9		
Q211	C	115.9	113.6	111.7	113.3	113.8	114.5	114.3	

< IC >										
		PAL	SECAM	NTSC	NTSC	S (V/C)	ANALOG	COMPO.		
				3.58	4.43		ROB	ROB	MENT	
IC102	⊗	8.8	8.8	0.0	8.8	0.0	0.0	0.0		
IC108	⊗	0.2	0.1	0.1	0.1	0.1	0.1	0.1	0.2	
⊕	10.8	9.7	1.7	1.7	1.7	1.7	1.8	1.8		
IC107	⊗	10.7	10.7	10.8	10.6	10.8	10.8	10.8	10.8	
⊕	1.2	10.7	0.0	0.0	0.0	0.0	0.0	0.0		
IC108	⊕	9.7	0.4	9.7	9.6	9.8	1.1	8.8		
IC109	⊗	11.3	11.3	0.0	10.8	0.0	0.0	0.0	0.0	
⊕	11.3	11.4	0.0	11.3	0.0	0.0	0.0	0.0		
⊕	11.7	0.0	0.0	11.7	0.0	0.0	0.0	0.0		
⊕	11.0	11.1	0.0	11.0	0.0	0.0	0.0	0.0		
IC110	⊕	2.1	2.2	2.5	2.5	2.5	2.5	2.5		
⊕	11.3	11.3	0.0	11.3	0.0	0.0	0.0	0.0		
⊕	11.3	11.3	0.0	0.0	0.0	0.0	0.0	0.0		
⊕	0.8	0.8	2.5	2.5	2.5	2.5	2.5			
IC111	⊕	1.7	1.7	2.5	2.6	2.5	2.5	2.5		
IC113	⊕	2.7	1.1	2.8	2.8	2.8	1.1	1.1		
⊕	4.2	4.3	4.2	4.3	4.3	4.8	4.8			
⊕	3.0	2.9	2.8	3.0	2.9	2.9	2.9	2.9		
⊕	2.2	2.3	2.8	2.2	1.8	2.8	2.8			
IC114	⊕	11.4	11.3	0.0	0.0	0.0	0.0	0.0		
⊕	3.7	3.7	3.8	3.8	3.8	3.9	3.9	3.9		
IC115	⊕	1.2	1.1	0.8	0.7	0.7	0.8	0.8		
⊕	3.5	3.5	3.4	2.8	3.4	3.4	3.4			
IC116	⊕	0.0	0.0	1.0	1.1	1.1	1.3	1.1		
IC120	⊕	5.5	5.6	5.8	5.6	5.8	5.6	5.6		
⊕	5.5	5.8	5.8	5.8	5.8	5.8	5.8	5.8		
IC121	⊕	5.3	5.3	5.4	5.2	5.2	5.1	5.1		
⊕	5.6	5.7	5.8	5.8	5.7	5.7	5.7			
⊕	5.8	5.7	5.8	5.6	5.7	5.7	5.7			
IC122	⊕	5.3	5.3	5.4	5.2	5.2	5.1	5.1		
⊕	5.3	5.3	5.4	5.2	5.2	5.1	5.1			
IC124	⊕	0.1	0.1	0.2	0.2	0.2	0.2	0.2		
IC125	⊕	1.4	1.4	1.3	1.4	1.5	1.5	1.5		
IC128	⊕	1.8	1.5	1.3	1.8	1.6	1.7	1.8		
⊕	1.8	1.5	1.3	1.8	1.6	1.8	1.7			
⊕	1.8	1.6	1.4	1.7	1.7	1.8	1.7			
IC127	⊕	3.0	2.9	2.8	3.0	3.1	3.0	3.0		
⊕	1.4	1.4	1.3	1.5	1.5	1.5	1.5			
⊕	2.1	2.7	2.4	2.8	2.8	2.8	2.8			

• B BOARD WAVEFORMS

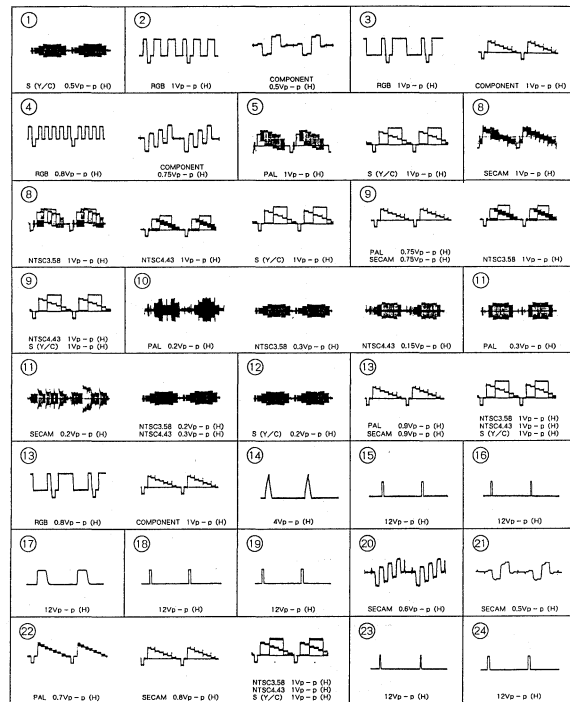

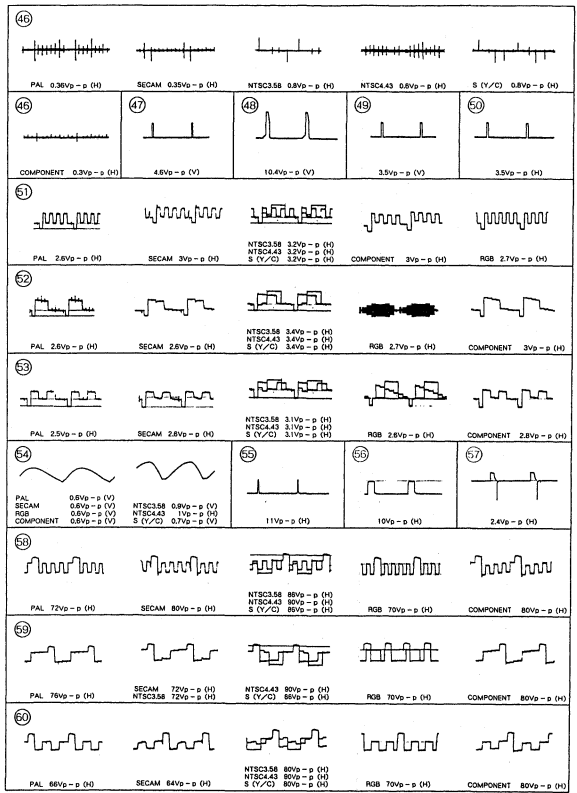
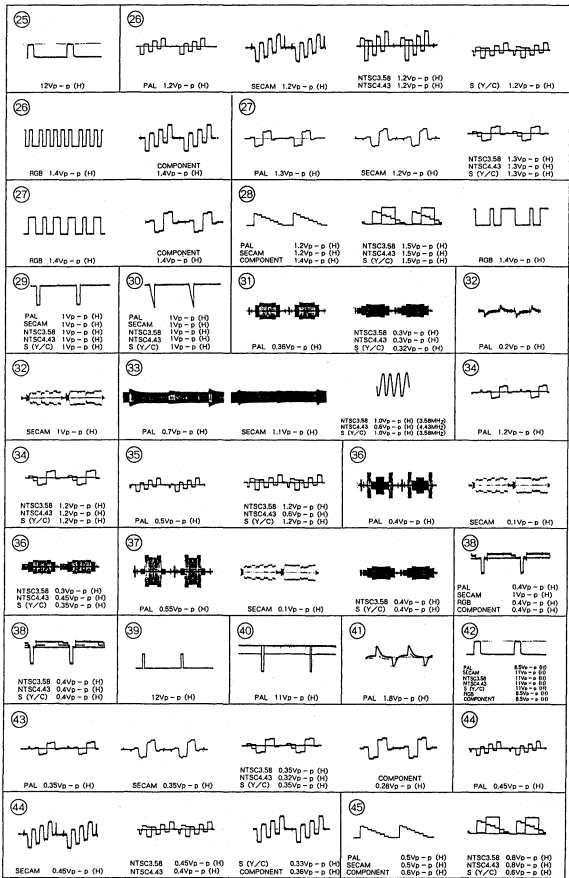

CE
A
B
C
D
E
F

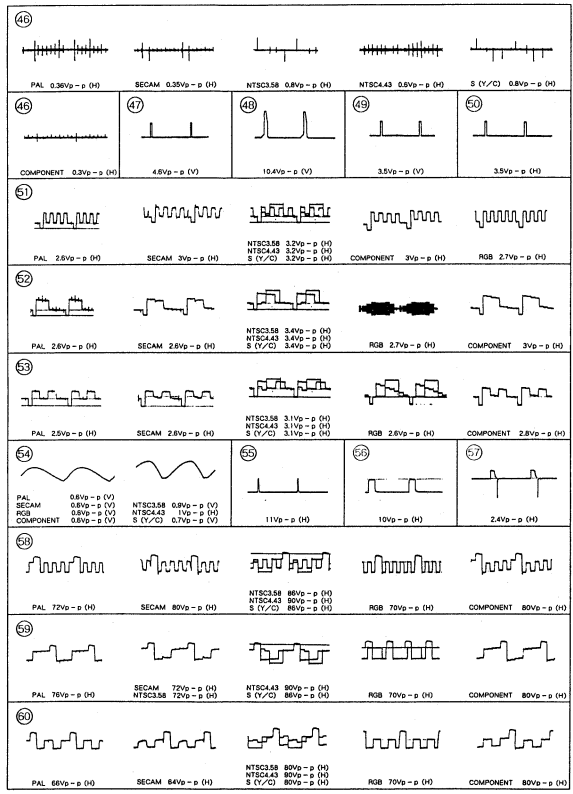

CB [CRT SOCKET]

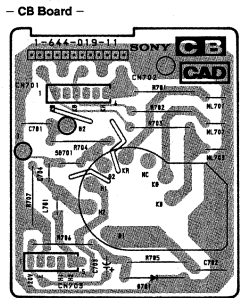
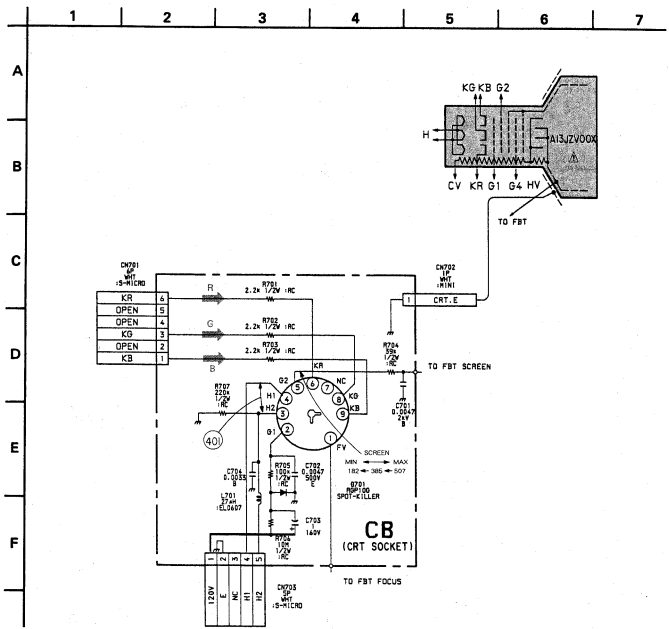

6-6. SEMICONDUCTORS

ANS265



MC14538BF



IMX1



2SK94-X4



1S2836



CXA1214P



M51279FP



2SA1091-0
2SC1390A-E
2SC2551-0
2SC25510



CR02AM-4TB

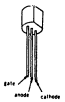

MA152WK
1S5226



CXA1478S

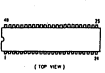

PC1377C

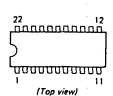

2SC2334-L
2SD835
2SD1134-C



DTZ15B
DTZ20B
DTZ24B
DTZ5.6A
DTZ6.2B



N13T1



CX23025



XRU4011BF
XRU4070BF



2SC2555



EGP20G



RD3.6ESB1
RD6.RESB2
RD8.2ESB3



LA7830



XRU4052BF
XRU4053BF
XRU4066BF



2SC2611
2SC2688-LK



ERC81-004
RU-3AM



RD6.2M-B1



LM7805CT
LM7812CT



XRU4584BF



2SC2958



1S583



SLP281C-50



LM358D
MM1140XF
MM1149XF
NJM2245M
XRA10353F

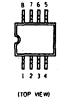

DTA144EK
DTC144EK
2SA1152-G
2SC2412K-QR



2SC3736



MA110



U05G



NOTE:
1: The
crij
are
The
part
num
1: The
they
serv
when

7-1.



6



REF. NO.	P
1	X
2	4
3	44
4	44
5	4
6	44
7	1
8	4A
9	4A
10	4
11	4A
12	4A
13	4A
14	4A
15	4

SECTION 7 EXPLODED VIEWS

NOTE:

- Items with no part number and no description are not stocked because they are seldom required for routine service.
- The construction parts of an assembled part are indicated with a collation number in the remark column.
- Items marked " * " are not stocked since they are seldom required for routine service. Some delay should be anticipated when ordering these items.

The components identified by shading and mark **△** are critical for safety.
Replace only with part number specified.

Les composants identifiés par une trame et une marque **△** sont critiques pour la sécurité.
Ne les remplacer que par une pièce portant le numéro spécifié.

7-1. CHASSIS

- : BVTP 3 x 8 7-685-646-79
- ▲: BVTP 3 x 12 7-685-648-79
- : +P 4 x 25 7-685-567-09
- : BVTT 4 x 8 7-682-561-09
- △: -PS 3 x 12 7-682-650-09

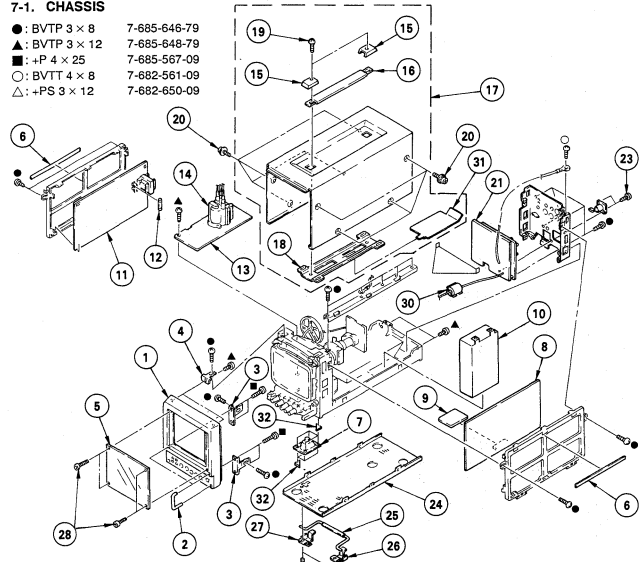

REF. NO.	PART NO.	DESCRIPTION	REF. NO.	PART NO.	DESCRIPTION	REMARK
1	X-4030-437-1	BEZEL ASSY	16	3-419-372-31	HANDLE	
2	4-034-844-01	HANDLE, PROTECTOR	17	*X-4036-439-1	CABINET ASSY	15, 16, 17, 18, 19, 31
3	*4-034-845-01	BRACKET (L), BEZEL	18	*X-4030-273-1	BE INFORCEMENT ASSY, HANDLE	
4	*4-034-846-01	BRACKET (U), BEZEL	19	4-035-452-01	SCREW (MAX10)	
5	4-036-714-01	PROTECTOR	20	4-034-834-01	SCREW (CLAW) (4X6), CASE	
6	*4-035-691-01	CLOTH, VIBRATION PROOF	21	*A-1275-104-A	QB BOARD, COMPLETE	
7	1-544-252-11	SPEAKER	22	*4-036-721-01	CHASSIS, R	
8	*A-1395-736-A	B BOARD, COMPLETE	23	4-035-802-01	SCREW (M2, 6X, 6)	
9	*A-1394-392-A	S BOARD, COMPLETE	24	*4-036-723-01	CABINET, BOTTOM	
10	*A-1413-720-21	SWITCHING REGULATOR (SOPS-1021)	30	4-036-695-01	STAND	
11	*A-1346-067-A	D BOARD, COMPLETE	26	4-036-696-01	BRACKET (R), STAND	
12	*A-1576-222-11	FUSE (H.B.C.) (15A/250V)	27	4-036-697-01	BRACKET (L), STAND	
13	*A-1195-057-A	P BOARD, COMPLETE	28	4-391-849-01	SCREW (3X12), TAPPING	
14	*A-1-839-526-11	TRANSFORMER ASSY, FLYBACK	30	1-543-925-11	CORE, FERRITE	
15	4-034-847-01	HANDLE (BASE)	31	4-037-556-01	INSULATOR (FBI)	
			32	4-037-348-01	CUSHION, SPEAKER	

7-2. PICTURE TUBE

▲: BVTP 3 × 12 7-685-648-79

□: PSW 3 × 10 7-682-649-09

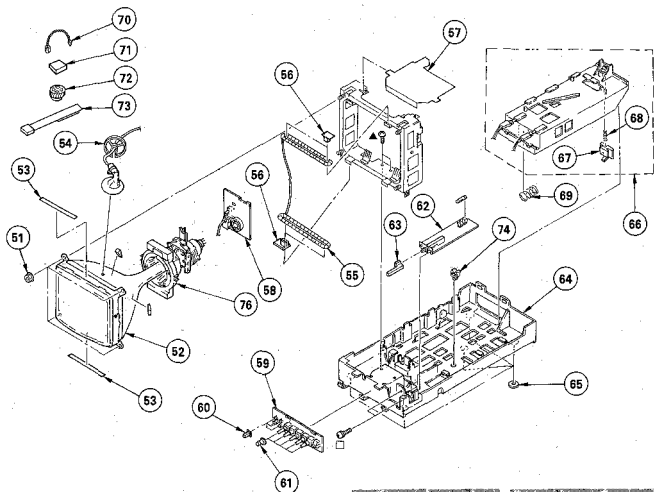

The components identified by shading and mark ▲ are critical for safety. Replace only with part number specified.

Les composants identifiés par une trame et une marque ▲ sont critiques pour la sécurité. Ne les remplacer que par une pièce portant le numéro spécifié.

REF. NO.	PART NO.	DESCRIPTION	REMARK	REF. NO.	PART NO.	DESCRIPTION	REMARK
51	4-304-511-00	FLANGE NUT, 5MM		66	*X-4030-163-1	GUIDE ASSY, BATTERY	67, 68
52	4-733-921-09	ERE, 06GV		67	4-034-861-01	KNOB, BATTERY	
53	4-036-700-01	CLOTH, PROTECTION		68	4-876-347-01	SPRING, COMPRESSION	
54	*4-034-856-01	HOLDER, HV CABLE		69	3-669-594-00	SPRING, COMPRESSION	
55	▲ 1-426-614-11	COIL, DEMAGNETIZATION		70	4-308-870-00	CLIP, LEAD WIRE	
56	4-380-534-01	CAP, DGC		71	1-452-126-11	MAGNET	
57	*4-036-713-01	INSULATOR		72	1-452-094-00	MAGNET, ROTATABLE DISK, 15MM φ	
58	*1-644-019-11	CB BOARD		73	X-4308-815-0	PERMALLOY ASSY, CONVERGENCE	
59	*1-644-020-11	HB BOARD		74	*4-314-320-00	HOLDER, WIRE	
60	4-034-849-01	SWITCH (SMALL), PUSH		76	▲ 1-451-325-11	DEFLECTION Yoke (Y063VA2)	
61	X-4030-162-1	KNOB ASSY, CONTROL					
62	*1-644-021-11	PC BOARD					
63	4-034-841-01	SWITCH, POWER					
64	*X-4030-438-1	CHASSIS ASSY, BOTTOM					
65	4-034-840-01	RUBBER, FOOT					

SECTION 8 ELECTRICAL PARTS LIST

NOTE:

The components identified by shading and mark **Δ** are critical for safety.

Replace only with part number specified.

Les composants identifiés par une trame et une marque **Δ** sont critiques pour la sécurité. Ne les remplacer que par une pièce portant le numéro spécifié.

* Items marked " * " are not stocked since they are seldom required for routine service. Some delay should be anticipated when ordering these items.

* All variable and adjustable resistors have characteristic curve B, unless otherwise noted.

RESISTORS

* All resistors are in ohms
* F : nonflammable

When indicating parts by reference number, please include the board name.

CAPACITORS

* MF : μ F, PF : μ MF * MOH : mH, OH : μ H

COILS

* The components identified by **Δ** in this manual have been carefully factory-selected for each set in order to satisfy regulations regarding X-ray radiation. Should replacement be required, replace only with the value originally used.

REF. NO.	PART NO.	DESCRIPTION	REMARK	REF. NO.	PART NO.	DESCRIPTION	REMARK
*A-1135-726-A	B BOARD, COMPLETE *****			C146	1-126-157-11	ELECT	10MF 20% 16V
*3-738-015-01	COVER, (DIA. 6) CARBON VR			C147	1-164-232-11	CERAMIC CHIP	0.01MF 10% 50V
	<FILTER>			C148	1-126-160-11	ELECT	1MF 20% 50V
BPF101	1-236-363-11	FILTER, BAND PASS		C149	1-163-022-00	CERAMIC CHIP	0.012MF 10% 50V
BPF102	1-236-364-11	FILTER, BAND PASS		C150	1-124-589-11	ELECT	47MF 20% 16V
	<CAPACITOR>			C151	1-163-131-00	CERAMIC CHIP	390PF 5% 50V
C101	1-124-589-11	ELECT	47MF 20% 16V	C152	1-163-101-00	CERAMIC CHIP	22PF 5% 50V
C102	1-163-031-11	CERAMIC CHIP	0.01MF 50V	C153	1-163-125-00	CERAMIC CHIP	220PF 5% 50V
C103	1-126-157-11	ELECT	10MF 20% 16V	C154	1-163-031-11	CERAMIC CHIP	0.01MF 5% 50V
C106	1-124-477-11	ELECT	47MF 20% 16V	C155	1-163-133-00	CERAMIC CHIP	470PF 5% 50V
C107	1-163-031-11	CERAMIC CHIP	0.01MF 50V	C156	1-164-299-11	CERAMIC CHIP	0.22MF 10% 25V
C108	1-124-477-11	ELECT	47MF 20% 16V	C157	1-163-229-11	CERAMIC CHIP	12PF 5% 50V
C109	1-124-477-11	ELECT	47MF 20% 16V	C158	1-124-477-11	ELECT	47MF 20% 16V
C110	1-124-120-11	ELECT	220PF 20% 16V	C159	1-163-229-11	CERAMIC CHIP	12PF 5% 50V
C111	1-163-031-11	CERAMIC CHIP	0.01MF 50V	C160	1-163-229-11	CERAMIC CHIP	12PF 5% 50V
C112	1-163-031-11	CERAMIC CHIP	0.01MF 50V	C161	1-124-902-00	ELECT	0.47MF 20% 50V
C113	1-163-031-11	CERAMIC CHIP	0.01MF 50V	C162	1-124-903-11	ELECT	0.1MF 20% 50V
C114	1-124-477-11	ELECT	47MF 20% 16V	C163	1-163-809-11	CERAMIC CHIP	0.047MF 10% 25V
C115	1-163-031-11	CERAMIC CHIP	0.01MF 50V	C164	1-163-809-11	CERAMIC CHIP	0.047MF 10% 25V
C116	1-124-589-11	ELECT	47MF 20% 16V	C165	1-163-809-11	CERAMIC CHIP	0.001MF 10% 50V
C117	1-126-154-11	ELECT	47MF 20% 6.3V	C166	1-163-031-11	CERAMIC CHIP	0.01MF 50V
C118	1-126-154-11	ELECT	47MF 20% 6.3V	C167	1-124-477-11	ELECT	47MF 20% 16V
C119	1-163-031-11	CERAMIC CHIP	0.01MF 50V	C168	1-163-031-11	CERAMIC CHIP	0.01MF 50V
C120	1-126-154-11	ELECT	47MF 20% 6.3V	C169	1-163-243-11	CERAMIC CHIP	47PF 5% 50V
C121	1-124-477-11	ELECT	47MF 20% 16V	C170	1-163-129-00	CERAMIC CHIP	330PF 5% 50V
C122	1-124-477-11	ELECT	47MF 20% 16V	C171	1-163-243-11	CERAMIC CHIP	47PF 5% 50V
C123	1-163-031-11	CERAMIC CHIP	0.01MF 50V	C172	1-163-129-00	CERAMIC CHIP	330PF 5% 50V
C125	1-126-154-11	ELECT	47MF 20% 6.3V	C173	1-124-589-11	ELECT	47MF 20% 16V
C126	1-163-031-11	CERAMIC CHIP	0.01MF 50V	C174	1-124-477-11	ELECT	47MF 20% 16V
C128	1-126-154-11	ELECT	47MF 20% 6.3V	C175	1-108-792-11	WTLAR	0.001MF 5% 50V
C129	1-163-031-11	CERAMIC CHIP	0.01MF 50V	C176	1-163-031-11	CERAMIC CHIP	0.01MF 50V
C130	1-163-031-11	CERAMIC CHIP	0.01MF 50V	C177	1-163-031-11	CERAMIC CHIP	0.01MF 50V
C131	1-163-031-11	CERAMIC CHIP	0.01MF 50V	C178	1-163-031-11	CERAMIC CHIP	0.01MF 50V
C132	1-124-589-11	ELECT	47MF 20% 16V	C179	1-126-160-11	ELECT	1MF 20% 50V
C133	1-124-589-11	ELECT	47MF 20% 16V	C180	1-163-031-11	CERAMIC CHIP	0.01MF 50V
C134	1-163-275-11	CERAMIC CHIP	0.001MF 5% 50V	C181	1-126-154-11	ELECT	47MF 20% 6.3V
C135	1-163-113-00	CERAMIC CHIP	68PF 5% 50V	C182	1-126-163-11	ELECT	4.7MF 20% 16V
C137	1-163-115-00	CERAMIC CHIP	82PF 5% 50V	C183	1-164-232-11	CERAMIC CHIP	0.01MF 10% 50V
C138	1-124-589-11	ELECT	47MF 20% 16V	C184	1-163-031-11	CERAMIC CHIP	0.01MF 50V
C139	1-163-031-11	CERAMIC CHIP	0.01MF 50V	C185	1-163-031-11	CERAMIC CHIP	0.01MF 50V
C140	1-163-205-00	CERAMIC CHIP	0.001MF 5% 50V	C186	1-163-099-00	CERAMIC CHIP	18PF 5% 50V
C141	1-163-141-00	CERAMIC CHIP	0.001MF 5% 50V	C187	1-163-031-11	CERAMIC CHIP	0.01MF 50V
C142	1-163-031-11	CERAMIC CHIP	0.01MF 50V	C188	1-163-031-11	CERAMIC CHIP	0.01MF 50V
C143	1-163-121-00	CERAMIC CHIP	150PF 5% 50V	C189	1-163-035-00	CERAMIC CHIP	0.047MF 50V
C144	1-163-101-00	CERAMIC CHIP	22PF 5% 50V	C190	1-163-121-00	CERAMIC CHIP	150PF 5% 50V
C145	1-163-131-00	CERAMIC CHIP	390PF 5% 50V	C191	1-163-031-11	CERAMIC CHIP	0.01MF 50V
				C192	1-163-031-11	CERAMIC CHIP	0.01MF 50V
				C193	1-124-589-11	ELECT	47MF 20% 16V
				C194	1-124-589-11	ELECT	47MF 20% 16V
				C195	1-124-589-11	ELECT	47MF 20% 16V

REF. NO.	PART NO.	DESCRIPTION	REMARK	REF. NO.	PART NO.	DESCRIPTION	REMARK
C196	1-124-589-11	ELECT 47MF	20% 16V	C264	1-163-123-00	CERAMIC CHIP 180PF	5% 50V
C197	1-124-589-11	ELECT 47MF	20% 16V	C265	1-163-129-00	CERAMIC CHIP 330PF	5% 50V
C198	1-124-589-11	ELECT 47MF	20% 16V	C266	1-126-320-11	ELECT 10MF	20% 16V
C199	1-124-589-11	ELECT 47MF	20% 16V	C267	1-126-320-11	ELECT 10MF	20% 16V
C202	1-124-589-11	ELECT 47MF	20% 16V	C268	1-124-477-11	ELECT 47MF	20% 16V
C203	1-124-589-11	ELECT 47MF	20% 16V	C269	1-164-004-11	CERAMIC CHIP 0.1MF	10% 25V
C204	1-124-589-11	ELECT 47MF	20% 16V	C270	1-164-004-11	CERAMIC CHIP 0.1MF	10% 25V
C205	1-163-101-00	CERAMIC CHIP 22PF	5% 50V	C271	1-163-809-11	CERAMIC CHIP 0.047MF	10% 25V
C206	1-164-298-11	CERAMIC CHIP 0.15MF	10% 25V	C272	1-163-129-00	CERAMIC CHIP 330PF	5% 50V
C207	1-164-298-11	CERAMIC CHIP 0.15MF	10% 25V	C273	1-163-129-00	CERAMIC CHIP 330PF	5% 50V
C208	1-163-101-00	CERAMIC CHIP 22PF	5% 50V	C274	1-124-477-11	ELECT 47MF	20% 16V
C209	1-164-004-11	CERAMIC CHIP 0.1MF	10% 25V	C275	1-163-119-00	CERAMIC CHIP 120PF	5% 50V
C210	1-124-589-11	ELECT 47MF	20% 16V	C277	1-163-097-00	CERAMIC CHIP 15PF	5% 50V
C211	1-124-589-11	ELECT 47MF	20% 16V	C278	1-163-809-11	CERAMIC CHIP 0.047MF	10% 25V
C212	1-124-589-11	ELECT 47MF	20% 16V	C279	1-126-157-11	ELECT 10MF	20% 16V
C213	1-124-589-11	ELECT 47MF	20% 16V	C280	1-163-117-00	CERAMIC CHIP 100PF	5% 50V
C214	1-126-157-11	ELECT 10MF	20% 16V	C281	1-163-031-11	CERAMIC CHIP 0.01MF	50V
C215	1-126-157-11	ELECT 10MF	20% 16V	C282	1-163-031-11	CERAMIC CHIP 0.01MF	50V
C216	1-126-157-11	ELECT 10MF	20% 16V	C283	1-163-031-11	CERAMIC CHIP 0.01MF	50V
C217	1-163-031-11	CERAMIC CHIP 0.01MF	50V	C295	1-163-031-11	CERAMIC CHIP 0.01MF	50V
C218	1-164-298-11	CERAMIC CHIP 0.15MF	10% 25V	C300	1-126-157-11	ELECT 10MF	20% 16V
C219	1-163-609-11	CERAMIC CHIP 0.001MF	10% 50V	C301	1-163-809-11	CERAMIC CHIP 0.047MF	10% 25V
C220	1-163-031-11	CERAMIC CHIP 0.01MF	50V	C302	1-124-589-11	ELECT 47MF	20% 16V
C221	1-124-903-11	ELECT 1MF	20% 50V	C303	1-126-157-11	ELECT 10MF	20% 16V
C222	1-163-093-00	CERAMIC CHIP 10PF	5% 50V	C304	1-163-125-00	CERAMIC CHIP 220PF	5% 50V
C223	1-163-031-11	CERAMIC CHIP 0.01MF	50V	C305	1-124-257-00	ELECT 2.2MF	20% 50V
C225	1-124-477-11	ELECT 47MF	20% 16V	C306	1-163-115-00	CERAMIC CHIP 82PF	5% 50V
C226	1-163-031-11	CERAMIC CHIP 0.01MF	50V	C307	1-163-145-00	CERAMIC CHIP 0.0015MF	5% 25V
C227	1-163-038-00	CERAMIC CHIP 0.1MF	25V	C308	1-164-004-11	CERAMIC CHIP 0.1MF	10% 25V
C228	1-163-986-00	CERAMIC CHIP 0.027MF	10% 25V	C309	1-164-004-11	CERAMIC CHIP 0.1MF	10% 25V
C229	1-163-031-11	CERAMIC CHIP 0.01MF	50V	C310	1-164-604-11	CERAMIC CHIP 0.1MF	10% 25V
C230	1-163-038-00	CERAMIC CHIP 0.1MF	25V	C313	1-163-115-00	CERAMIC CHIP 82PF	5% 50V
C231	1-163-986-00	CERAMIC CHIP 0.027MF	10% 25V	C314	1-126-157-11	ELECT 10MF	20% 16V
C232	1-163-031-11	CERAMIC CHIP 0.01MF	50V	C315	1-164-299-11	CERAMIC CHIP 0.22MF	10% 25V
C233	1-163-031-11	CERAMIC CHIP 0.01MF	50V	C316	1-126-157-11	ELECT 10MF	20% 16V
C234	1-163-038-00	CERAMIC CHIP 0.1MF	25V	C317	1-163-031-11	CERAMIC CHIP 0.01MF	50V
C235	1-163-986-00	CERAMIC CHIP 0.027MF	10% 25V	C318	1-163-103-00	CERAMIC CHIP 27PF	5% 50V
C236	1-163-031-11	CERAMIC CHIP 0.01MF	50V	C319	1-163-103-00	CERAMIC CHIP 27PF	5% 50V
C237	1-163-031-11	CERAMIC CHIP 0.01MF	50V	C320	1-163-103-00	CERAMIC CHIP 27PF	5% 50V
C238	1-164-299-11	CERAMIC CHIP 0.22MF	10% 25V	C321	1-163-121-00	CERAMIC CHIP 150PF	5% 50V
C239	1-163-809-11	CERAMIC CHIP 0.047MF	10% 25V	C322	1-163-121-00	CERAMIC CHIP 150PF	5% 50V
C240	1-163-809-11	CERAMIC CHIP 0.047MF	10% 25V	C324	1-163-121-00	CERAMIC CHIP 150PF	5% 50V
C241	1-163-809-11	CERAMIC CHIP 0.047MF	10% 25V	C340	1-163-205-00	CERAMIC CHIP 0.001MF	5% 50V
C242	1-163-113-00	CERAMIC CHIP 68PF	5% 50V	C344	1-163-092-00	CERAMIC CHIP 9PF	0.25PF 50V
C243	1-163-031-11	CERAMIC CHIP 0.01MF	50V	C345	1-163-105-00	CERAMIC CHIP 33PF	5% 50V
C244	1-163-103-00	CERAMIC CHIP 27PF	5% 50V	C346	1-163-105-00	CERAMIC CHIP 33PF	5% 50V
C245	1-163-105-00	CERAMIC CHIP 33PF	5% 50V	C347	1-163-105-00	CERAMIC CHIP 33PF	5% 50V
C246	1-163-809-11	CERAMIC CHIP 0.047MF	10% 25V	C1293	1-163-115-00	CERAMIC CHIP 82PF	5% 50V
C247	1-163-809-11	CERAMIC CHIP 0.047MF	10% 25V	C1294	1-163-115-00	CERAMIC CHIP 82PF	5% 50V
C248	1-163-809-11	CERAMIC CHIP 0.047MF	10% 25V	C1295	1-163-115-00	CERAMIC CHIP 82PF	5% 50V
C249	1-126-101-11	ELECT 100MF	20% 16V	C1296	1-163-107-00	CERAMIC CHIP 39PF	5% 50V
C250	1-163-017-00	CERAMIC CHIP 0.0047MF	10% 50V	C1297	1-163-099-00	CERAMIC CHIP 18PF	5% 50V
C251	1-110-364-11	MYLAR 0.1NF	10% 200V	C1298	1-163-109-00	CERAMIC CHIP 47PF	5% 50V
C252	1-124-046-00	ELECT 10MF	20% 160V	C1299	1-163-093-00	CERAMIC CHIP 10PF	5% 50V
C253	1-124-477-11	ELECT 47MF	20% 16V	C1300	1-126-160-11	ELECT 1MF	20% 50V
C254	1-163-031-11	CERAMIC CHIP 0.01MF	50V	C1301	1-126-160-11	ELECT 1MF	20% 50V
C255	1-124-477-11	ELECT 47MF	20% 16V	C1302	1-126-160-11	ELECT 1MF	20% 50V
C256	1-163-129-00	CERAMIC CHIP 330PF	5% 50V				
C257	1-163-129-00	CERAMIC CHIP 330PF	5% 50V				
C258	1-163-129-00	CERAMIC CHIP 330PF	5% 50V				
C260	1-124-465-00	ELECT 0.47MF	20% 50V				
C261	1-137-193-11	FILM 0.39MF	5% 50V				
C262	1-124-465-00	ELECT 0.47MF	20% 50V				
C263	1-163-031-11	CERAMIC CHIP 0.01MF	50V				

<FILTER BLOCK>

CFM101 1-464-880-11 FILTER BLOCK, COM (CFB-2)

REF. NO.	PART NO.	DESCRIPTION	REMARK	REF. NO.	PART NO.	DESCRIPTION	REMARK
<CONNECTOR>							
CN101	1-506-478-11	PIN, CONNECTOR 13P		D148	8-719-404-46	DIODE MA110	
CN102	*1-564-506-11	PLUG, CONNECTOR 3P		D149	8-719-404-46	DIODE MA110	
CN103	*1-565-503-11	CONNECTOR, BOARD TO BOARD 12P		D150	8-719-404-46	DIODE MA110	
CN104	1-506-477-11	PIN, CONNECTOR 12P		D151	8-719-404-46	DIODE MA110	
CN105	*1-564-509-11	PLUG, CONNECTOR 6P		D152	8-719-404-46	DIODE MA110	
				D153	8-719-977-20	DIODE DT28, 2B	
CN107	1-506-478-11	PIN, CONNECTOR 13P		D154	8-719-404-46	DIODE MA110	
<TRAP MODULE>							
CTR101	1-236-366-11	MODULE, TRAP		D155	8-719-404-46	DIODE MA110	
CTR102	1-236-365-11	MODULE, TRAP		D156	8-719-404-46	DIODE MA110	
<TRIMMER>							
CV101	1-141-418-11	CAP. ADJ		D157	8-719-901-83	DIODE 1S583	
CV102	1-141-418-11	CAP. ADJ		D158	8-719-901-83	DIODE 1S583	
				D159	8-719-901-83	DIODE 1S583	
<DIODE>							
D101	8-719-404-46	DIODE MA110		D160	8-719-404-46	DIODE MA110	
D102	8-719-404-46	DIODE MA110		D161	8-719-404-46	DIODE MA110	
D104	8-719-404-46	DIODE MA110		D162	8-719-404-46	DIODE MA110	
D105	8-719-404-46	DIODE MA110		D170	8-719-404-46	DIODE MA110	
D106	8-719-404-46	DIODE MA110		D171	8-719-404-46	DIODE MA110	
D107	8-719-404-46	DIODE MA110		D172	8-719-404-46	DIODE MA110	
D108	8-719-404-46	DIODE MA110		D285	8-719-404-46	DIODE MA110	
D109	8-719-404-46	DIODE MA110		D289	8-719-404-46	DIODE MA110	
D110	8-719-404-46	DIODE MA110		D341	8-719-404-46	DIODE MA110	
D111	8-719-404-46	DIODE MA110		D342	8-719-104-34	DIODE 1S2836	
D112	8-719-404-46	DIODE MA110		D343	8-719-800-76	DIODE 1S5226	
D113	8-719-404-46	DIODE MA110		D344	8-719-105-XX	DIODE 806, 2M-B1	
D114	8-719-404-46	DIODE MA110		D345	8-719-901-83	DIODE 1S583	
D115	8-719-404-46	DIODE MA110		D346	8-719-901-83	DIODE 1S583	
D116	8-719-404-46	DIODE MA110		D347	8-719-901-83	DIODE 1S583	
D117	8-719-404-46	DIODE MA110		D348	8-719-800-76	DIODE 1S5226	
D118	8-719-404-46	DIODE MA110		D349	8-719-800-76	DIODE 1S5226	
D119	8-719-404-46	DIODE MA110		D350	8-719-800-76	DIODE 1S5226	
D120	8-719-404-46	DIODE MA110		D393	8-719-404-46	DIODE MA110	
D121	8-719-404-46	DIODE MA110		<DELAY LINE>			
D122	8-719-404-46	DIODE MA110		DL101	1-415-632-11	DELAY LINE, Y	
D123	8-719-404-46	DIODE MA110		<C>			
D125	8-719-404-46	DIODE MA110		IC102	8-759-501-21	IC MM149XF	
D126	8-719-404-46	DIODE MA110		IC103	8-759-501-21	IC MM149XF	
D127	8-719-404-46	DIODE MA110		IC104	8-759-048-09	IC MM148XF	
D128	8-719-400-18	DIODE MA152MK		IC105	8-759-048-09	IC MM148XF	
D129	8-719-404-46	DIODE MA110		IC106	8-759-009-51	IC MC14538BF	
D130	8-719-800-76	DIODE 1S5226		IC107	8-759-509-57	IC XRU4584BF	
D131	8-719-800-76	DIODE 1S5226		IC108	8-759-509-17	IC XRU40538F	
D132	8-719-800-76	DIODE 1S5226		IC109	8-759-509-37	IC XRU4070BF	
D133	8-719-404-46	DIODE MA110		IC110	8-759-509-17	IC XRU40538F	
D134	8-719-404-46	DIODE MA110		IC111	8-759-509-17	IC XRU40538F	
D135	8-719-404-46	DIODE MA110		IC112	8-759-924-12	IC LM7805CT	
D136	8-719-404-46	DIODE MA110		IC113	8-759-631-08	IC M51279PF	
D137	8-719-404-46	DIODE MA110		IC114	8-759-509-13	IC XRU40528F	
D138	8-719-404-46	DIODE MA110		IC115	8-759-509-13	IC XRU40528F	
D139	8-719-404-46	DIODE MA110		IC116	8-759-509-05	IC XRU40666F	
D142	8-719-404-46	DIODE MA110		IC117	8-759-711-32	IC NJM2245M	
D143	8-719-404-46	DIODE MA110		IC118	8-759-711-32	IC NJM2245M	
D144	8-719-404-46	DIODE MA110		IC119	8-759-711-32	IC NJM2245M	
D145	8-719-404-46	DIODE MA110		IC120	8-759-509-05	IC XRU40666F	
D146	8-719-404-46	DIODE MA110		IC121	8-759-509-17	IC XRU40538F	
D147	8-719-404-46	DIODE MA110		IC122	8-759-998-98	IC LM358D	
				IC123	8-759-998-98	IC LM358D	
				IC124	8-752-052-62	IC CXA147KS	
				IC125	8-759-509-05	IC XRU40666F	
				IC126	8-759-509-17	IC XRU40538F	

REF. NO.	PART NO.	DESCRIPTION	REMARK	REF. NO.	PART NO.	DESCRIPTION	REMARK
IC127	8-759-998-98	IC LM358D		Q141	8-729-920-74	TRANSISTOR 25C2412K-QR	
IC128	8-759-998-98	IC LM358D		Q142	8-729-920-74	TRANSISTOR 25C2412K-QR	
IC129	8-759-998-98	IC LM358D		Q143	8-729-920-74	TRANSISTOR 25C2412K-QR	
<COIL>							
L101	1-410-470-11	INDUCTOR 10UH		Q144	8-729-920-74	TRANSISTOR 25C2412K-QR	
L102	1-410-090-41	INDUCTOR 18MH		Q145	8-729-920-74	TRANSISTOR 25C2412K-QR	
L103	1-412-002-31	INDUCTOR CHIP 4.7UH		Q146	8-729-255-12	TRANSISTOR 25C2551-0	
L104	1-412-002-31	INDUCTOR CHIP 4.7UH		Q147	8-729-255-12	TRANSISTOR 25C2551-0	
L105	1-412-002-31	INDUCTOR CHIP 4.7UH		Q148	8-729-216-22	TRANSISTOR 25A1162-G	
L106	1-410-470-11	INDUCTOR 10UH		Q149	8-729-200-17	TRANSISTOR 25A1091-0	
L107	1-410-470-11	INDUCTOR 10UH		Q150	8-729-920-74	TRANSISTOR 25C2412K-QR	
L108	1-408-418-00	INDUCTOR 56UH		Q151	8-729-216-22	TRANSISTOR 25A1162-G	
L109	1-408-418-00	INDUCTOR 56UH		Q152	8-729-200-17	TRANSISTOR 25A1091-0	
L110	1-408-418-00	INDUCTOR 56UH		Q153	8-729-920-74	TRANSISTOR 25C2412K-QR	
L112	1-408-419-00	INDUCTOR 68UH		Q154	8-729-216-22	TRANSISTOR 25A1162-G	
L116	1-412-011-31	INDUCTOR CHIP 27UH		Q155	8-729-200-17	TRANSISTOR 25A1091-0	
L117	1-412-011-31	INDUCTOR CHIP 27UH		Q157	8-729-326-11	TRANSISTOR 25C2611	
L118	1-412-011-31	INDUCTOR CHIP 27UH		Q158	8-729-326-11	TRANSISTOR 25C2611	
L250	1-410-997-31	INDUCTOR CHIP 2.2UH		Q159	8-729-326-11	TRANSISTOR 25C2611	
L251	1-410-999-11	INDUCTOR CHIP 3.3UH		Q160	8-729-920-74	TRANSISTOR 25C2412K-QR	
L252	1-410-478-11	INDUCTOR 47UH		Q161	8-729-216-22	TRANSISTOR 25A1162-G	
L300	1-410-482-31	INDUCTOR 100UH		Q162	8-729-920-74	TRANSISTOR 25C2412K-QR	
<TRANSISTOR>							
Q101	8-729-920-74	TRANSISTOR 25C2412K-QR		Q163	8-729-920-74	TRANSISTOR 25C2412K-QR	
Q102	8-729-920-74	TRANSISTOR 25C2412K-QR		Q164	8-729-901-01	TRANSISTOR DTC144EK	
Q103	8-729-920-74	TRANSISTOR 25C2412K-QR		Q165	8-729-216-22	TRANSISTOR 25A1162-G	
Q104	8-729-920-74	TRANSISTOR 25C2412K-QR		Q166	8-729-216-22	TRANSISTOR 25A1162-G	
Q106	8-729-920-74	TRANSISTOR 25C2412K-QR		Q167	8-729-216-22	TRANSISTOR 25A1162-G	
Q107	8-729-920-74	TRANSISTOR 25C2412K-QR		Q168	8-729-216-22	TRANSISTOR 25A1162-G	
Q108	8-729-216-22	TRANSISTOR 25A1162-G		Q170	8-729-920-74	TRANSISTOR 25C2412K-QR	
Q109	8-729-901-01	TRANSISTOR DTC144EK		Q171	8-729-920-74	TRANSISTOR 25C2412K-QR	
Q112	8-729-920-74	TRANSISTOR 25C2412K-QR		Q172	8-729-920-74	TRANSISTOR 25C2412K-QR	
Q113	8-729-920-74	TRANSISTOR 25C2412K-QR		Q173	8-729-216-22	TRANSISTOR 25A1162-G	
Q114	8-729-216-22	TRANSISTOR 25A1162-G		Q174	8-729-216-22	TRANSISTOR 25A1162-G	
Q115	8-729-920-74	TRANSISTOR 25C2412K-QR		Q175	8-729-216-22	TRANSISTOR 25A1162-G	
Q116	8-729-920-74	TRANSISTOR 25C2412K-QR		Q176	8-729-216-22	TRANSISTOR 25A1162-G	
Q117	8-729-216-22	TRANSISTOR 25A1162-G		Q177	8-729-920-74	TRANSISTOR 25C2412K-QR	
Q118	8-729-920-74	TRANSISTOR 25C2412K-QR		Q179	8-729-901-01	TRANSISTOR DTC144EK	
Q119	8-729-216-22	TRANSISTOR 25A1162-G		Q190	8-729-216-22	TRANSISTOR 25A1162-G	
Q120	8-729-216-22	TRANSISTOR 25A1162-G		Q191	8-729-920-74	TRANSISTOR 25C2412K-QR	
Q121	8-729-920-74	TRANSISTOR 25C2412K-QR		Q192	8-729-920-74	TRANSISTOR 25C2412K-QR	
Q122	8-729-216-22	TRANSISTOR 25A1162-G		Q193	8-729-920-74	TRANSISTOR 25C2412K-QR	
Q123	8-729-920-74	TRANSISTOR 25C2412K-QR		Q194	8-729-920-74	TRANSISTOR 25C2412K-QR	
Q124	8-729-216-22	TRANSISTOR 25A1162-G		Q195	8-729-216-22	TRANSISTOR 25A1162-G	
Q125	8-729-920-74	TRANSISTOR 25C2412K-QR		Q196	8-729-920-74	TRANSISTOR 25C2412K-QR	
Q126	8-729-901-01	TRANSISTOR DTC144EK		Q197	8-729-216-22	TRANSISTOR 25A1162-G	
Q127	8-729-216-22	TRANSISTOR 25A1162-G		Q198	8-729-216-22	TRANSISTOR 25A1162-G	
Q128	8-729-216-22	TRANSISTOR 25A1162-G		Q199	8-729-216-22	TRANSISTOR 25A1162-G	
Q129	8-729-901-01	TRANSISTOR DTC144EK		Q200	8-729-901-06	TRANSISTOR DTC144EK	
Q130	8-729-216-22	TRANSISTOR 25A1162-G		Q201	8-729-216-22	TRANSISTOR 25A1162-G	
Q131	8-729-920-74	TRANSISTOR 25C2412K-QR		Q202	8-729-216-22	TRANSISTOR 25A1162-G	
Q132	8-729-216-22	TRANSISTOR 25A1162-G		Q203	8-729-216-22	TRANSISTOR 25A1162-G	
Q133	8-729-920-74	TRANSISTOR 25C2412K-QR		Q204	8-729-216-22	TRANSISTOR 25A1162-G	
Q134	8-729-901-01	TRANSISTOR DTC144EK		Q205	8-729-216-22	TRANSISTOR 25A1162-G	
Q135	8-729-920-74	TRANSISTOR 25C2412K-QR		Q206	8-729-216-22	TRANSISTOR 25A1162-G	
Q136	8-729-907-26	TRANSISTOR 1MX1		Q208	8-729-216-22	TRANSISTOR 25A1162-G	
Q137	8-729-907-26	TRANSISTOR 1MX1		Q209	8-729-255-12	TRANSISTOR 25C2551-0	
Q138	8-729-907-26	TRANSISTOR 1MX1		Q210	8-729-255-12	TRANSISTOR 25C2551-0	
Q139	8-729-216-22	TRANSISTOR 25A1162-G		Q211	8-729-255-12	TRANSISTOR 25C2551-0	
Q140	8-729-920-74	TRANSISTOR 25C2412K-QR		Q212	8-729-109-44	TRANSISTOR 25K94-X4	
Q141	8-729-920-74	TRANSISTOR 25C2412K-QR		Q299	8-729-920-74	TRANSISTOR 25C2412K-QR	
<RESISTOR>							
JR101	1-216-295-00	METAL GLAZE	0 5%	1/10W			

B

REF. NO.	PART NO.	DESCRIPTION	REMARK	REF. NO.	PART NO.	DESCRIPTION	REMARK
JR105	1-216-295-00	METAL GLAZE	0 5% 1/10W	R174	1-216-069-00	METAL GLAZE	6.8R 5% 1/10W
JR118	1-216-295-00	METAL GLAZE	0 5% 1/10W	R175	1-216-057-00	METAL GLAZE	2.2K 5% 1/10W
JR132	1-216-295-00	METAL GLAZE	0 5% 1/10W	R176	1-216-065-00	METAL GLAZE	4.7K 5% 1/10W
JR133	1-216-295-00	METAL GLAZE	0 5% 1/10W	R177	1-216-073-00	METAL GLAZE	10K 5% 1/10W
JR178	1-216-295-00	METAL GLAZE	0 5% 1/10W	R178	1-216-089-00	METAL GLAZE	47K 5% 1/10W
L113	1-216-296-00	METAL GLAZE	0 5% 1/8W	R179	1-216-081-00	METAL GLAZE	22K 5% 1/10W
L114	1-216-296-00	METAL GLAZE	0 5% 1/8W	R180	1-216-679-11	METAL CHIP	15K 0.50% 1/10W
L115	1-216-296-00	METAL GLAZE	0 5% 1/8W	R181	1-216-071-00	METAL GLAZE	8.2K 5% 1/10W
R101	1-216-089-00	METAL GLAZE	47K 5% 1/10W	R182	1-216-683-11	METAL CHIP	22K 0.50% 1/10W
R102	1-216-025-00	METAL GLAZE	100 5% 1/10W	R183	1-216-691-11	METAL CHIP	47K 0.50% 1/10W
R103	1-216-091-00	METAL GLAZE	56K 5% 1/10W	R184	1-216-699-11	METAL CHIP	100K 0.50% 1/10W
R104	1-216-061-00	METAL GLAZE	5.3K 5% 1/10W	R185	1-216-073-00	METAL GLAZE	10K 5% 1/10W
R105	1-216-025-00	METAL GLAZE	100 5% 1/10W	R186	1-216-113-00	METAL GLAZE	470K 5% 1/10W
R106	1-216-065-00	METAL GLAZE	4.7K 5% 1/10W	R187	1-216-073-00	METAL GLAZE	10K 5% 1/10W
R107	1-216-025-00	METAL GLAZE	100 5% 1/10W	R188	1-216-113-00	METAL GLAZE	470K 5% 1/10W
R108	1-216-113-00	METAL GLAZE	470K 5% 1/10W	R189	1-216-103-00	METAL GLAZE	180K 5% 1/10W
R109	1-216-065-00	METAL GLAZE	4.7K 5% 1/10W	R190	1-216-107-00	METAL GLAZE	270K 5% 1/10W
R110	1-216-049-00	METAL GLAZE	1K 5% 1/10W	R191	1-216-097-00	METAL GLAZE	100K 5% 1/10W
R111	1-216-063-00	METAL GLAZE	3.9K 5% 1/10W	R192	1-216-103-00	METAL GLAZE	180K 5% 1/10W
R112	1-216-049-00	METAL GLAZE	1K 5% 1/10W	R193	1-216-105-00	METAL GLAZE	220K 5% 1/10W
R113	1-249-401-11	CARBON	47 5% 1/4W F	R194	1-216-089-00	METAL GLAZE	47K 5% 1/10W
R114	1-216-045-00	METAL GLAZE	680 5% 1/10W	R195	1-216-113-00	METAL GLAZE	470K 5% 1/10W
R115	1-216-061-00	METAL GLAZE	3.3K 5% 1/10W	R196	1-216-073-00	METAL GLAZE	10K 5% 1/10W
R117	1-216-073-00	METAL GLAZE	10K 5% 1/10W	R197	1-216-671-11	METAL CHIP	6.8K 0.50% 1/10W
R118	1-216-025-00	METAL GLAZE	100 5% 1/10W	R198	1-216-049-00	METAL GLAZE	1K 5% 1/10W
R119	1-216-647-11	METAL CHIP	680 0.50% 1/10W	R199	1-216-065-00	METAL GLAZE	4.7K 5% 1/10W
R120	1-216-647-11	METAL CHIP	680 0.50% 1/10W	R200	1-216-065-00	METAL GLAZE	4.7K 5% 1/10W
R121	1-216-025-00	METAL GLAZE	100 5% 1/10W	R201	1-216-043-00	METAL GLAZE	560 5% 1/10W
R123	1-216-073-00	METAL GLAZE	10K 5% 1/10W	R202	1-216-033-00	METAL GLAZE	220 5% 1/10W
R124	1-216-073-00	METAL GLAZE	10K 5% 1/10W	R203	1-216-045-00	METAL GLAZE	680 5% 1/10W
R125	1-216-083-00	METAL GLAZE	27K 5% 1/10W	R204	1-216-073-00	METAL GLAZE	10K 5% 1/10W
R126	1-216-093-00	METAL GLAZE	68K 5% 1/10W	R205	1-216-073-00	METAL GLAZE	10K 5% 1/10W
R127	1-216-037-00	METAL GLAZE	330 5% 1/10W	R206	1-216-043-00	METAL GLAZE	560 5% 1/10W
R128	1-216-083-00	METAL GLAZE	27K 5% 1/10W	R207	1-216-045-00	METAL GLAZE	680 5% 1/10W
R129	1-216-067-00	METAL GLAZE	5.6K 5% 1/10W	R208	1-216-671-11	METAL CHIP	6.8K 0.50% 1/10W
R130	1-216-097-00	METAL GLAZE	100K 5% 1/10W	R209	1-216-043-00	METAL GLAZE	560 5% 1/10W
R136	1-216-091-00	METAL GLAZE	56K 5% 1/10W	R210	1-216-033-00	METAL GLAZE	220 5% 1/10W
R137	1-216-045-00	METAL GLAZE	680 5% 1/10W	R211	1-216-099-00	METAL GLAZE	120K 5% 1/10W
R138	1-216-657-11	METAL CHIP	1.5K 0.50% 1/10W	R212	1-216-065-00	METAL GLAZE	4.7K 5% 1/10W
R139	1-216-079-00	METAL GLAZE	18K 5% 1/10W	R213	1-216-043-00	METAL GLAZE	560 5% 1/10W
R140	1-216-653-11	METAL CHIP	1.2K 0.50% 1/10W	R214	1-216-043-00	METAL GLAZE	560 5% 1/10W
R141	1-216-063-00	METAL GLAZE	3.9K 5% 1/10W	R215	1-216-125-00	METAL GLAZE	1.5M 5% 1/10W
R142	1-216-073-00	METAL GLAZE	10K 5% 1/10W	R216	1-216-043-00	METAL GLAZE	560 5% 1/10W
R143	1-216-085-00	METAL GLAZE	33K 5% 1/10W	R217	1-216-033-00	METAL GLAZE	220 5% 1/10W
R144	1-216-089-00	METAL GLAZE	47K 5% 1/10W	R218	1-216-295-00	METAL GLAZE	0 5% 1/10W
R145	1-216-065-00	METAL GLAZE	4.7K 5% 1/10W	R219	1-216-043-00	METAL GLAZE	560 5% 1/10W
R146	1-216-037-00	METAL GLAZE	330 5% 1/10W	R220	1-216-043-00	METAL GLAZE	560 5% 1/10W
R148	1-216-671-11	METAL CHIP	6.8K 0.50% 1/10W	R221	1-216-035-00	METAL GLAZE	270 5% 1/10W
R155	1-216-655-11	METAL CHIP	1.5K 0.50% 1/10W	R222	1-216-033-00	METAL GLAZE	220 5% 1/10W
R157	1-216-679-11	METAL CHIP	15K 0.50% 1/10W	R223	1-216-073-00	METAL GLAZE	10K 5% 1/10W
R158	1-216-677-11	METAL CHIP	12K 0.50% 1/10W	R224	1-216-073-00	METAL GLAZE	10K 5% 1/10W
R160	1-216-065-00	METAL GLAZE	4.7K 5% 1/10W	R225	1-216-095-00	METAL GLAZE	82K 5% 1/10W
R161	1-216-089-00	METAL GLAZE	47K 5% 1/10W	R226	1-216-073-00	METAL GLAZE	10K 5% 1/10W
R163	1-216-073-00	METAL GLAZE	10K 5% 1/10W	R227	1-216-035-00	METAL GLAZE	270 5% 1/10W
R164	1-216-677-11	METAL CHIP	12K 0.50% 1/10W	R228	1-216-065-00	METAL GLAZE	4.7K 5% 1/10W
R165	1-216-107-00	METAL GLAZE	270K 5% 1/10W	R229	1-216-113-00	METAL GLAZE	470K 5% 1/10W
R166	1-216-681-11	METAL CHIP	18K 0.50% 1/10W	R230	1-216-081-00	METAL GLAZE	22K 5% 1/10W
R167	1-216-635-11	METAL CHIP	220 0.50% 1/10W	R231	1-216-113-00	METAL GLAZE	470K 5% 1/10W
R168	1-216-103-00	METAL GLAZE	180K 5% 1/10W	R232	1-216-105-00	METAL GLAZE	220K 5% 1/10W
R169	1-216-033-00	METAL GLAZE	220 5% 1/10W	R233	1-216-073-00	METAL GLAZE	10K 5% 1/10W
R170	1-216-089-00	METAL GLAZE	47K 5% 1/10W	R234	1-216-041-00	METAL GLAZE	470 5% 1/10W
R171	1-216-053-00	METAL GLAZE	1.5K 5% 1/10W	R235	1-216-041-00	METAL GLAZE	470 5% 1/10W
R172	1-216-043-00	METAL GLAZE	560 5% 1/10W	R236	1-216-677-00	METAL GLAZE	15K 5% 1/10W
R173	1-216-093-00	METAL GLAZE	68K 5% 1/10W				

REF. NO.	PART NO.	DESCRIPTION	REMARK	REF. NO.	PART NO.	DESCRIPTION	REMARK
R237	1-216-025-00	METAL GLAZE	100 5%	1/10W	R305	1-216-049-00	METAL GLAZE 1K 5% 1/10W
R238	1-216-065-00	METAL GLAZE	4.7K 5%	1/10W	R306	1-216-089-00	METAL GLAZE 47K 5% 1/10W
R239	1-216-065-00	METAL GLAZE	4.7K 5%	1/10W	R307	1-216-033-00	METAL GLAZE 220 5% 1/10W
R240	1-216-033-00	METAL GLAZE	220 5%	1/10W	R308	1-216-089-00	METAL GLAZE 47K 5% 1/10W
R241	1-216-073-00	METAL GLAZE	16K 5%	1/10W	R309	1-216-089-00	METAL GLAZE 47K 5% 1/10W
R242	1-216-051-00	METAL GLAZE	1.2K 5%	1/10W	R310	1-216-033-00	METAL GLAZE 220 5% 1/10W
R243	1-216-113-00	METAL GLAZE	470K 5%	1/10W	R311	1-216-089-00	METAL GLAZE 47K 5% 1/10W
R244	1-216-065-00	METAL GLAZE	4.7K 5%	1/10W	R312	1-216-089-00	METAL GLAZE 47K 5% 1/10W
R245	1-216-679-11	METAL CHIP	15K 0.50%	1/10W	R313	1-216-033-00	METAL GLAZE 220 5% 1/10W
R246	1-216-103-00	METAL GLAZE	180K 5%	1/10W	R314	1-216-089-00	METAL GLAZE 47K 5% 1/10W
R247	1-216-093-00	METAL GLAZE	68K 5%	1/10W	R315	1-216-113-00	METAL GLAZE 470K 5% 1/10W
R248	1-216-095-00	METAL GLAZE	82K 5%	1/10W	R316	1-216-105-00	METAL GLAZE 220K 5% 1/10W
R249	1-216-109-00	METAL GLAZE	330K 5%	1/10W	R317	1-216-109-00	METAL GLAZE 330K 5% 1/10W
R250	1-216-101-00	METAL GLAZE	150K 5%	1/10W	R318	1-216-105-00	METAL GLAZE 220K 5% 1/10W
R251	1-216-105-00	METAL GLAZE	220K 5%	1/10W	R319	1-216-099-00	METAL GLAZE 120K 5% 1/10W
R252	1-216-101-00	METAL GLAZE	150K 5%	1/10W	R320	1-216-099-00	METAL GLAZE 120K 5% 1/10W
R253	1-216-101-00	METAL GLAZE	150K 5%	1/10W	R321	1-216-043-00	METAL GLAZE 560 5% 1/10W
R254	1-216-033-00	METAL GLAZE	220 5%	1/10W	R325	1-216-097-00	METAL GLAZE 190K 5% 1/10W
R255	1-216-061-00	METAL GLAZE	3.3K 5%	1/10W	R326	1-216-113-00	METAL GLAZE 470K 5% 1/10W
R256	1-216-107-00	METAL GLAZE	270K 5%	1/10W	R328	1-216-073-00	METAL GLAZE 16K 5% 1/10W
R258	1-216-041-00	METAL GLAZE	470 5%	1/10W	R329	1-216-107-00	METAL GLAZE 270K 5% 1/10W
R259	1-216-073-00	METAL GLAZE	16K 5%	1/10W	R330	1-216-109-00	METAL GLAZE 220K 5% 1/10W
R260	1-216-025-00	METAL GLAZE	100 5%	1/10W	R331	1-216-025-00	METAL GLAZE 100 5% 1/10W
R261	1-216-035-00	METAL GLAZE	270 5%	1/10W	R332	1-216-097-00	METAL GLAZE 100K 5% 1/10W
R262	1-216-097-00	METAL GLAZE	100K 5%	1/10W	R333	1-216-097-00	METAL GLAZE 100K 5% 1/10W
R263	1-216-029-00	METAL GLAZE	150 5%	1/10W	R334	1-216-025-00	METAL GLAZE 100 5% 1/10W
R264	1-216-065-00	METAL GLAZE	4.7K 5%	1/10W	R335	1-216-099-00	METAL GLAZE 120K 5% 1/10W
R265	1-216-067-00	METAL GLAZE	5.6K 5%	1/10W	R336	1-216-095-00	METAL GLAZE 82K 5% 1/10W
R266	1-216-073-00	METAL GLAZE	16K 5%	1/10W	R338	1-216-025-00	METAL GLAZE 100 5% 1/10W
R267	1-216-073-00	METAL GLAZE	16K 5%	1/10W	R339	1-216-099-00	METAL GLAZE 120K 5% 1/10W
R268	1-216-081-00	METAL GLAZE	22K 5%	1/10W	R340	1-216-095-00	METAL GLAZE 82K 5% 1/10W
R269	1-216-101-00	METAL GLAZE	150K 5%	1/10W	R342	1-216-047-00	METAL GLAZE 820 5% 1/10W
R270	1-216-081-00	METAL GLAZE	22K 5%	1/10W	R343	1-216-053-00	METAL GLAZE 1.5K 5% 1/10W
R271	1-216-025-00	METAL GLAZE	100 5%	1/10W	R344	1-216-664-11	METAL CHIP 3.6K 0.50% 1/10W
R272	1-216-101-00	METAL GLAZE	150K 5%	1/10W	R345	1-216-661-11	METAL CHIP 2.7K 0.50% 1/10W
R273	1-216-113-00	METAL GLAZE	470K 5%	1/10W	R346	1-216-105-00	METAL GLAZE 220K 5% 1/10W
R275	1-216-081-00	METAL GLAZE	22K 5%	1/10W	R348	1-216-061-00	METAL GLAZE 3.3K 5% 1/10W
R276	1-216-037-00	METAL GLAZE	330 5%	1/10W	R349	1-216-650-11	METAL CHIP 910 0.50% 1/10W
R277	1-216-049-00	METAL GLAZE	1K 5%	1/10W	R350	1-216-653-11	METAL CHIP 1.2K 0.50% 1/10W
R278	1-216-057-00	METAL GLAZE	2.2K 5%	1/10W	R351	1-216-650-11	METAL CHIP 910 0.50% 1/10W
R279	1-216-037-00	METAL GLAZE	330 5%	1/10W	R352	1-216-653-11	METAL CHIP 1.2K 0.50% 1/10W
R280	1-216-061-00	METAL GLAZE	3.3K 5%	1/10W	R353	1-216-650-11	METAL CHIP 910 0.50% 1/10W
R281	1-216-061-00	METAL GLAZE	3.3K 5%	1/10W	R354	1-216-653-11	METAL CHIP 1.2K 0.50% 1/10W
R282	1-216-037-00	METAL GLAZE	330 5%	1/10W	R355	1-216-113-00	METAL GLAZE 470K 5% 1/10W
R283	1-216-049-00	METAL GLAZE	1K 5%	1/10W	R356	1-216-113-00	METAL GLAZE 470K 5% 1/10W
R284	1-216-057-00	METAL GLAZE	2.2K 5%	1/10W	R357	1-216-095-00	METAL GLAZE 82K 5% 1/10W
R285	1-216-037-00	METAL GLAZE	330 5%	1/10W	R358	1-216-113-00	METAL GLAZE 470K 5% 1/10W
R286	1-216-061-00	METAL GLAZE	3.3K 5%	1/10W	R359	1-216-081-00	METAL GLAZE 22K 5% 1/10W
R287	1-216-061-00	METAL GLAZE	3.3K 5%	1/10W	R360	1-216-089-00	METAL GLAZE 47K 5% 1/10W
R288	1-216-037-00	METAL GLAZE	330 5%	1/10W	R363	1-216-069-00	METAL GLAZE 6.8K 5% 1/10W
R289	1-216-049-00	METAL GLAZE	1K 5%	1/10W	R364	1-216-073-00	METAL GLAZE 16K 5% 1/10W
R290	1-216-057-00	METAL GLAZE	2.2K 5%	1/10W	R365	1-216-073-00	METAL GLAZE 16K 5% 1/10W
R291	1-216-037-00	METAL GLAZE	330 5%	1/10W	R366	1-216-244-00	METAL GLAZE 82K 5% 1/8W
R292	1-216-061-00	METAL GLAZE	3.3K 5%	1/10W	R367	1-216-244-00	METAL GLAZE 82K 5% 1/8W
R293	1-216-061-00	METAL GLAZE	3.3K 5%	1/10W	R368	1-216-055-00	METAL GLAZE 1.8K 5% 1/10W
R295	1-216-057-00	METAL GLAZE	2.2K 5%	1/10W	R369	1-216-248-00	METAL GLAZE 120K 5% 1/8W
R296	1-216-659-11	METAL CHIP	2.2K 0.50%	1/10W	R370	1-216-115-00	METAL GLAZE 560K 5% 1/10W
R297	1-216-659-11	METAL CHIP	2.2K 0.50%	1/10W	R371	1-216-067-00	METAL GLAZE 5.6K 5% 1/10W
R298	1-216-065-00	METAL GLAZE	4.7K 5%	1/10W	R372	1-216-115-00	METAL GLAZE 560K 5% 1/10W
R300	1-216-065-00	METAL GLAZE	4.7K 5%	1/10W	R374	1-216-115-00	METAL GLAZE 560K 5% 1/10W
R301	1-216-065-00	METAL GLAZE	4.7K 5%	1/10W	R375	1-216-683-11	METAL CHIP 22K 0.50% 1/10W
R302	1-216-113-00	METAL GLAZE	470K 5%	1/10W	R376	1-216-663-11	METAL CHIP 3.3K 0.50% 1/10W
R303	1-216-065-00	METAL GLAZE	4.7K 5%	1/10W	R378	1-216-025-00	METAL GLAZE 100 5% 1/10W
R304	1-216-049-00	METAL GLAZE	1K 5%	1/10W			

B

REF. NO.	PART NO.	DESCRIPTION	REMARK	REF. NO.	PART NO.	DESCRIPTION	REMARK
R379	1-216-641-11	METAL CHIP	390 0.50%	1/10W	R1051	1-216-105-00	METAL GLAZE 220K 5% 1/10W
R380	1-216-668-11	METAL CHIP	5.1K 0.50%	1/10W	R1058	1-216-109-00	METAL GLAZE 330K 5% 1/10W
R381	1-216-089-00	METAL GLAZE	47R 5%	1/10W	R1059	1-216-109-00	METAL GLAZE 330K 5% 1/10W
R382	1-216-025-00	METAL GLAZE	100 5%	1/10W	R1060	1-216-109-00	METAL GLAZE 330K 5% 1/10W
R383	1-216-641-11	METAL CHIP	390 0.50%	1/10W	R1061	1-216-109-00	METAL GLAZE 330K 5% 1/10W
R384	1-216-668-11	METAL CHIP	5.1K 0.50%	1/10W	R1062	1-216-103-00	METAL GLAZE 180K 5% 1/10W
R385	1-216-117-00	METAL GLAZE	680K 5%	1/10W	R1063	1-216-103-00	METAL GLAZE 180K 5% 1/10W
R386	1-216-025-00	METAL GLAZE	100 5%	1/10W	R1064	1-216-103-00	METAL GLAZE 180K 5% 1/10W
R387	1-216-641-11	METAL CHIP	390 0.50%	1/10W	R1065	1-216-103-00	METAL GLAZE 180K 5% 1/10W
R388	1-216-668-11	METAL CHIP	5.1K 0.50%	1/10W	R1066	1-216-073-00	METAL GLAZE 10K 5% 1/10W
R390	1-216-105-00	METAL GLAZE	220K 5%	1/10W	R1067	1-216-073-00	METAL GLAZE 10K 5% 1/10W
R391	1-216-081-00	METAL GLAZE	22K 5%	1/10W	R1068	1-216-049-00	METAL GLAZE 1K 5% 1/10W
R392	1-216-113-00	METAL GLAZE	470K 5%	1/10W	R1069	1-216-133-00	METAL GLAZE 3.3M 5% 1/10W
R393	1-216-085-00	METAL GLAZE	53K 5%	1/10W	R1070	1-216-085-00	METAL GLAZE 33K 5% 1/10W
R394	1-216-121-00	METAL GLAZE	1K 5%	1/10W	R1071	1-216-113-00	METAL GLAZE 470K 5% 1/10W
R397	1-249-437-11	CARBON	47K 5%	1/4W F	R1072	1-216-099-00	METAL GLAZE 120K 5% 1/10W
R398	1-249-434-11	CARBON	27K 5%	1/4W F	R1073	1-216-131-11	METAL GLAZE 2.7K 5% 1/10W
R399	1-216-073-00	METAL GLAZE	10K 5%	1/10W	R1075	1-216-065-00	METAL GLAZE 4.7K 5% 1/10W
R1001	1-216-073-00	METAL GLAZE	10K 5%	1/10W	R1076	1-216-101-00	METAL GLAZE 150K 5% 1/10W
R1002	1-216-047-00	METAL GLAZE	820 5%	1/10W	R1077	1-216-103-00	METAL GLAZE 180K 5% 1/10W
R1003	1-216-055-00	METAL GLAZE	1.8K 5%	1/10W	R1078	1-216-085-00	METAL GLAZE 33K 5% 1/10W
R1004	1-216-061-00	METAL GLAZE	3.3K 5%	1/10W	R1079	1-216-073-00	METAL GLAZE 10K 5% 1/10W
R1005	1-216-047-00	METAL GLAZE	820 5%	1/10W	R1080	1-216-097-00	METAL GLAZE 100K 5% 1/10W
R1006	1-216-055-00	METAL GLAZE	1.8K 5%	1/10W	R1081	1-216-097-00	METAL GLAZE 100K 5% 1/10W
R1007	1-216-061-00	METAL GLAZE	3.3K 5%	1/10W	R1083	1-216-065-00	METAL GLAZE 4.7K 5% 1/10W
R1008	1-216-047-00	METAL GLAZE	820 5%	1/10W	R1084	1-216-063-00	METAL GLAZE 3.9K 5% 1/10W
R1009	1-216-055-00	METAL GLAZE	1.8K 5%	1/10W	R1088	1-216-047-00	METAL GLAZE 820 5% 1/10W
R1010	1-216-061-00	METAL GLAZE	3.3K 5%	1/10W	R1090	1-216-045-00	METAL GLAZE 680 5% 1/10W
R1011	1-216-033-00	METAL GLAZE	220 5%	1/10W	R1091	1-216-045-00	METAL GLAZE 680 5% 1/10W
R1012	1-216-051-00	METAL GLAZE	1.2K 5%	1/10W	R1092	1-216-045-00	METAL GLAZE 680 5% 1/10W
R1013	1-216-051-00	METAL GLAZE	1.2K 5%	1/10W	R1093	1-216-121-00	METAL GLAZE 1K 5% 1/10W
R1014	1-216-246-00	METAL GLAZE	100K 5%	1/10W	R1094	1-216-075-00	METAL GLAZE 12K 5% 1/10W
R1015	1-216-033-00	METAL GLAZE	220 5%	1/10W	R1095	1-216-075-00	METAL GLAZE 12K 5% 1/10W
R1016	1-216-089-00	METAL GLAZE	47K 5%	1/10W	R1096	1-216-075-00	METAL GLAZE 12K 5% 1/10W
R1017	1-216-045-00	METAL GLAZE	680 5%	1/10W	R1200	1-216-699-11	METAL CHIP 100K 0.50% 1/10W
R1018	1-216-043-00	METAL GLAZE	560 5%	1/10W	R1201	1-218-754-11	METAL CHIP 120K 0.50% 1/10W
R1019	1-216-033-00	METAL GLAZE	220 5%	1/10W	R1207	1-216-061-00	METAL GLAZE 3.3K 5% 1/10W
R1020	1-216-089-00	METAL GLAZE	47K 5%	1/10W	R1208	1-216-065-00	METAL GLAZE 4.7K 5% 1/10W
R1021	1-216-045-00	METAL GLAZE	680 5%	1/10W	R1220	1-216-059-00	METAL GLAZE 2.7K 5% 1/10W
R1022	1-216-025-00	METAL GLAZE	100 5%	1/10W	R1221	1-216-059-00	METAL GLAZE 2.7K 5% 1/10W
R1023	1-216-073-00	METAL GLAZE	10K 5%	1/10W	R1222	1-216-059-00	METAL GLAZE 2.7K 5% 1/10W
R1024	1-216-025-00	METAL GLAZE	100 5%	1/10W	R1223	1-216-689-11	METAL GLAZE 39K 5% 1/10W
R1025	1-216-033-00	METAL GLAZE	220 5%	1/10W	R1225	1-215-876-00	METAL OXIDE 15K 5% 1W F
R1026	1-216-061-00	METAL GLAZE	3.3K 5%	1/10W	R1226	1-215-876-00	METAL OXIDE 15K 5% 1W F
R1027	1-216-101-00	METAL GLAZE	150K 5%	1/10W	R1227	1-215-876-00	METAL OXIDE 15K 5% 1W F
R1028	1-216-033-00	METAL GLAZE	220 5%	1/10W	R1228	1-249-821-11	CARBON 2.2K 5% 1/4W F
R1029	1-216-061-00	METAL GLAZE	3.3K 5%	1/10W	R1229	1-249-421-11	CARBON 2.2K 5% 1/4W F
R1031	1-216-033-00	METAL GLAZE	220 5%	1/10W	R1230	1-249-421-11	CARBON 2.2K 5% 1/4W F
R1032	1-216-061-00	METAL GLAZE	3.3K 5%	1/10W	R1231	1-216-031-00	METAL GLAZE 180 5% 1/10W
R1033	1-216-081-00	METAL GLAZE	22K 5%	1/10W	R1232	1-216-031-00	METAL GLAZE 180 5% 1/10W
R1034	1-216-089-00	METAL GLAZE	47K 5%	1/10W	R1233	1-216-031-00	METAL GLAZE 180 5% 1/10W
R1035	1-216-073-00	METAL GLAZE	10K 5%	1/10W	R1234	1-216-031-00	METAL GLAZE 180 5% 1/10W
R1036	1-216-089-00	METAL GLAZE	47K 5%	1/10W	R1235	1-216-031-00	METAL GLAZE 180 5% 1/10W
R1038	1-216-081-00	METAL GLAZE	22K 5%	1/10W	R1236	1-216-031-00	METAL GLAZE 180 5% 1/10W
R1040	1-216-025-00	METAL GLAZE	100 5%	1/10W	R1237	1-249-419-11	CARBON 1.5K 5% 1/4W F
R1042	1-216-047-00	METAL GLAZE	820 5%	1/10W	R1238	1-249-419-11	CARBON 1.5K 5% 1/4W F
R1043	1-216-057-00	METAL GLAZE	2.2K 5%	1/10W	R1239	1-249-419-11	CARBON 1.5K 5% 1/4W F
R1044	1-216-061-00	METAL GLAZE	3.3K 5%	1/10W	R1270	1-216-079-00	METAL GLAZE 18K 5% 1/10W
R1045	1-216-125-00	METAL GLAZE	1.5M 5%	1/10W	R1280	1-216-109-00	METAL GLAZE 330K 5% 1/10W
R1046	1-216-689-11	METAL CHIP	39K 0.50%	1/10W	R1290	1-216-071-00	METAL GLAZE 8.2K 5% 1/10W
R1047	1-216-065-00	METAL GLAZE	4.7K 5%	1/10W	R1291	1-216-081-00	METAL GLAZE 22K 5% 1/10W
R1048	1-216-049-00	METAL GLAZE	1K 5%	1/10W	R1294	1-216-069-00	METAL GLAZE 6.8K 5% 1/10W
R1049	1-216-085-00	METAL GLAZE	33K 5%	1/10W	R1295	1-216-109-00	METAL GLAZE 330K 5% 1/10W
R1050	1-216-059-00	METAL GLAZE	2.7K 5%	1/10W			

The components identified by shading and mark Δ are critical for safety.
Replace only with part number specified.

Les composants identifiés par une trame et une marque Δ sont critiques pour la sécurité.
Ne les remplacer que par une pièce portant le numéro spécifié.

B

P

REF. NO.	PART NO.	DESCRIPTION	REMARK
R1296	1-216-095-00	METAL GLAZE	82K 5% 1/10W
R1297	1-216-077-00	METAL GLAZE	15K 5% 1/10W
R1298	1-216-077-00	METAL GLAZE	15K 5% 1/10W
R1299	1-216-075-00	METAL GLAZE	12K 5% 1/10W
R1300	1-216-089-00	METAL GLAZE	47K 5% 1/10W
R1301	1-216-065-00	METAL GLAZE	4.7K 5% 1/10W
R1302	1-216-113-00	METAL GLAZE	470K 5% 1/10W
R1303	1-216-113-00	METAL GLAZE	470K 5% 1/10W
R1304	1-216-093-00	METAL GLAZE	68K 5% 1/10W
R1305	1-216-686-11	METAL CHIP	30R 0.50X 1/10W
R1306	1-216-063-00	METAL GLAZE	3.9K 5% 1/10W
R1307	1-216-041-00	METAL GLAZE	470 5% 1/10W
R1308	1-216-041-00	METAL GLAZE	470 5% 1/10W
R1309	1-216-063-00	METAL GLAZE	3.9K 5% 1/10W
R1310	1-216-119-00	METAL GLAZE	820K 5% 1/10W
R1313	1-216-101-00	METAL GLAZE	150K 5% 1/10W
R1314	1-216-053-00	METAL GLAZE	1.5K 5% 1/10W
R1315	1-216-077-00	METAL GLAZE	15K 5% 1/10W
R1320	1-216-083-00	METAL GLAZE	27K 5% 1/10W
R1321	1-216-093-00	METAL GLAZE	68K 5% 1/10W
R1322	1-216-037-00	METAL GLAZE	330 5% 1/10W
R1323	1-216-057-00	METAL GLAZE	2.2K 5% 1/10W
R1324	1-216-121-00	METAL GLAZE	1M 5% 1/10W
R1325	1-216-085-00	METAL GLAZE	33K 5% 1/10W
R1326	1-216-065-00	METAL GLAZE	4.7K 5% 1/10W
R1327	1-216-099-00	METAL GLAZE	120K 5% 1/10W
R1328	1-216-059-00	METAL GLAZE	120K 5% 1/10W
R1329	1-216-093-00	METAL GLAZE	68K 5% 1/10W
R1330	1-216-063-00	METAL GLAZE	3.9K 5% 1/10W
R1331	1-216-051-00	METAL GLAZE	1.2K 5% 1/10W
R1332	1-216-057-00	METAL GLAZE	2.2K 5% 1/10W
R1333	1-216-057-00	METAL GLAZE	2.2K 5% 1/10W
R1334	1-216-095-00	METAL GLAZE	1.8K 5% 1/10W
R1335	1-216-035-00	METAL GLAZE	270 5% 1/10W
R1336	1-216-089-00	METAL GLAZE	47K 5% 1/10W
R1337	1-216-113-00	METAL GLAZE	470K 5% 1/10W
R1338	1-216-049-00	METAL GLAZE	1K 5% 1/10W
R1339	1-216-097-00	METAL GLAZE	100K 5% 1/10W
R1340	1-216-097-00	METAL GLAZE	100K 5% 1/10W
R1341	1-216-111-00	METAL GLAZE	390K 5% 1/10W
R1342	1-216-694-11	METAL CHIP	62K 0.50X 1/10W
R1343	1-216-121-00	METAL GLAZE	1M 5% 1/10W
R1344	1-216-073-00	METAL GLAZE	10K 5% 1/10W
R1345	1-216-055-00	METAL GLAZE	1.8K 5% 1/10W
R1346	1-216-047-00	METAL GLAZE	820 5% 1/10W
R1347	1-216-073-00	METAL GLAZE	10K 5% 1/10W
R1348	1-216-073-00	METAL GLAZE	10K 5% 1/10W
R1349	1-216-073-00	METAL GLAZE	10K 5% 1/10W
R1350	1-216-073-00	METAL GLAZE	10K 5% 1/10W
R1351	1-216-073-00	METAL GLAZE	10K 5% 1/10W
R1352	1-216-073-00	METAL GLAZE	10K 5% 1/10W
R1353	1-216-115-00	METAL GLAZE	560K 5% 1/10W
R1371	1-216-057-00	METAL GLAZE	2.2K 5% 1/10W
R1372	1-216-057-00	METAL GLAZE	2.2K 5% 1/10W
R1373	1-216-057-00	METAL GLAZE	2.2K 5% 1/10W
R1392	1-216-089-00	METAL GLAZE	47K 5% 1/10W
R1393	1-216-109-00	METAL GLAZE	330K 5% 1/10W

<VARIABLE RESISTOR>

RV101	1-241-763-11	RES, ADJ, CERMET 4.7K
RV102	1-241-763-11	RES, ADJ, CERMET 4.7K
RV103	1-238-009-11	RES, ADJ, CARBON 220
RV104	1-238-009-11	RES, ADJ, CARBON 220

REF. NO.	PART NO.	DESCRIPTION	REMARK
RV105	1-238-012-11	RES, ADJ, CARBON 1K	
RV106	1-238-012-11	RES, ADJ, CARBON 1K	
RV107	1-238-012-11	RES, ADJ, CARBON 1K	
RV108	1-238-016-11	RES, ADJ, CARBON 10K	
RV109	1-241-765-21	RES, ADJ, CERMET 22K	
RV110	1-238-016-11	RES, ADJ, CARBON 10K	
RV111	1-238-016-11	RES, ADJ, CARBON 10K	
RV112	1-238-019-11	RES, ADJ, CARBON 47K	
RV113	1-238-019-11	RES, ADJ, CARBON 47K	
RV114	1-238-019-11	RES, ADJ, CARBON 47K	
RV115	1-238-017-11	RES, ADJ, CARBON 22K	
RV116	1-238-017-11	RES, ADJ, CARBON 22K	
RV118	1-238-017-11	RES, ADJ, CARBON 22K	
RV119	1-238-017-11	RES, ADJ, CARBON 22K	
RV120	1-238-017-11	RES, ADJ, CARBON 22K	
RV121	1-238-017-11	RES, ADJ, CARBON 22K	
RV122	1-238-017-11	RES, ADJ, CARBON 22K	
RV123	1-238-013-11	RES, ADJ, CARBON 2.2K	
RV124	1-238-012-11	RES, ADJ, CARBON 1K	
RV125	1-238-012-11	RES, ADJ, CARBON 1K	
RV205	1-238-017-11	RES, ADJ, CARBON 22K	
<MODULE>			
SEP101	1-808-654-11	MODULE	
<CRYSTAL>			
X101	1-527-722-00	OSCILLATOR, CRYSTAL	
X102	1-577-259-11	VIBRATOR, CRYSTAL	

#A-1190-164-A P BOARD, COMPLETE *****			

#4-363-404-00 HOLDER, IC			
4-382-854-01 SCREW (M3X8), P. SW (**)			
4-879-937-00 SHEET, MICA			

<CAPACITOR>			
C801	1-126-104-11	ELECT 470MF	20% 35V
C802	1-162-318-11	CERAMIC 0.001MF	10% 500V
C803	1-102-228-00	CERAMIC 470PF	10% 500V
C804	1-123-935-00	ELECT 33MF	20% 160V
C805	1-101-004-00	CERAMIC 0.01MF	50V
C806	1-124-480-11	ELECT 470MF	20% 25V
C807	1-102-228-00	CERAMIC 470PF	10% 500V
C808	1-106-367-00	MYLAR 0.01MF	10% 100V
C809	1-106-375-12	MYLAR 0.022MF	10% 100V
C810	1-162-318-11	CERAMIC 0.001MF	10% 500V
C811	1-137-544-91	FILM 0.01MF	2% 600V
C812	1-137-546-91	FILM 0.01MF	2% 600V
C813	1-106-385-00	MYLAR 0.05MF	5% 230V
C814	1-106-383-00	MYLAR 0.047MF	10% 100V
C815	1-126-233-11	ELECT 22MF	20% 50V
C816	1-124-798-11	ELECT 1MF	20% 160V
C817	1-130-800-00	FILM 2.2MF	10% 250V
C818	1-102-228-00	CERAMIC 470PF	10% 500V
C819	1-162-116-00	CERAMIC 680PF	10% 2KV
C820	1-162-116-00	CERAMIC 680PF	10% 2KV
C821	1-162-116-00	CERAMIC 680PF	10% 2KV

P Fc QB

Les composants identifiés par une trame et une marque Δ sont critiques pour la sécurité. Ne les remplacer que par une pièce portant le numéro spécifié.

The components identified by shading and mark Δ are critical for safety. Replace only with part number specified.

REF. NO.	PART NO.	DESCRIPTION	REMARK
<CONNECTOR>			
CN801	*1-564-595-11	PLUG, CONNECTOR 14P	
CN802	*1-508-766-00	PIN, CONNECTOR (5MM PITCH) 4P	
CN803	*1-564-508-11	PLUG, CONNECTOR 5P	
CN805	*1-560-123-00	PLUG, CONNECTOR (2.5MM) 3P	
<DIODE>			
D801	8-719-300-33	DIODE RD-3AM	
D802	8-719-300-33	DIODE RU-3AM	
D803	8-719-300-33	DIODE RU-3AM	
D804	8-719-979-85	DIODE BGP20G	
D805	8-719-300-33	DIODE RU-3AM	
D806	8-719-300-33	DIODE RU-3AM	
D807	8-719-105-XX	DIODE EDG. 2M-B1	
D808	8-719-018-72	THYRISTOR CRO2AN-4YB	
D809	8-719-911-55	DIODE U05G	
D810	8-719-911-55	DIODE U05G	
D811	8-719-911-55	DIODE U05G	
D813	8-719-300-33	DIODE RU-3AM	
<COIL>			
L802	1-459-442-00	COIL (WITH CORE)	
L803	1-422-613-11	COIL, AIR CORE	
L804	1-459-109-00	COIL, DUST CORE	
L805	1-460-846-11	COIL, HORIZONTAL LINEARITY	
L806	1-414-099-11	INDUCTOR, MICRO	
L807	1-414-099-11	INDUCTOR, MICRO	
<NEON LAMP>			
NL801	1-519-108-XX	LAMP, NEON	
<TRANSISTOR>			
Q801	8-729-195-82	TRANSISTOR 2SC2958-L	
Q802	8-729-201-62	TRANSISTOR 2SC2555-2	
Q803	8-729-906-24	TRANSISTOR 2SD835	
<RESISTOR>			
R801	1-249-383-11	CARBON 1.5 5% 1/4W F	
R802	1-249-377-11	CARBON 0.47 5% 1/4W F	
R803	1-216-049-00	METAL GLAZE 1K 5% 1/10W F	
R804	1-249-419-11	CARBON 1.5K 5% 1/4W F	
R805	1-215-892-11	METAL OXIDE 1K 5% 2W F	
R807	1-216-425-11	METAL OXIDE 56 5% 1W F	
R808	1-202-846-00	SOLID 470X 20% 1/2W F	
R809	1-216-089-00	METAL GLAZE 47X 5% 1/10W F	
R810	1-249-421-11	CARBON 2.2K 5% 1/4W F	
R811	1-216-049-00	METAL GLAZE 1K 5% 1/10W F	
R812	1-249-439-11	CARBON 68K 5% 1/4W F	
R813	1-249-414-11	CARBON 560 5% 1/4W F	
R814	1-249-377-11	CARBON 0.47 5% 1/4W F	
<VARIABLE RESISTOR>			
BV801	1-223-102-00	RES, ADJ. WIREWOUND 120	
<TRANSFORMER>			
T801	1-437-082-31	HDT	

REF. NO.	PART NO.	DESCRIPTION	REMARK
T802	1-439-526-11	TRANSFORMER ASSY. FLYBACK	

*1-644-021-11 FC BOARD			

*4-341-751-01	EYELET	EY3, EY4	
*4-341-752-01	EYELET	EY1, EY2, EY3, EY4	
<CONNECTOR>			
CN601	*1-580-689-11	PIN, CONNECTOR (PC BOARD) 4P	
CN602	*1-508-765-00	PIN, CONNECTOR (5MM PITCH) 3P	
CN603	*1-564-507-11	PLUG, CONNECTOR 4P	
<FUSE>			
F601	1-576-230-01	FUSE (T.C.C.) (3.15A/250V)	
	1-533-223-11	CLIP, FUSE: F601	
<RESISTOR>			
R602	1-202-721-00	SOLID 1.5K 20% 1/2W	
<SWITCH>			
S601	1-692-050-01	SWITCH, PUSH (AC POWER LINE)	

*A-1275-104-A QB BOARD, COMPLETE			

	1-537-434-11	TERMINAL BOARD, INPUT/OUTPUT	
*4-341-752-01	EYELET	EY8, EY9	
<CAPACITOR>			
C401	1-124-234-00	ELECT 22MF 20% 16V	
C402	1-163-031-11	CERAMIC CHIP 0.01MF 50V	
C403	1-124-234-00	ELECT 22MF 20% 16V	
C409	1-124-234-00	ELECT 22MF 20% 16V	
C410	1-124-234-00	ELECT 22MF 20% 16V	
C411	1-124-234-00	ELECT 22MF 20% 16V	
C412	1-124-234-00	ELECT 22MF 20% 16V	
C414	1-126-157-11	ELECT 10MF 20% 16V	
C415	1-126-157-11	ELECT 10MF 20% 16V	
C418	1-126-157-11	ELECT 10MF 20% 16V	
C419	1-126-157-11	ELECT 10MF 20% 16V	
C420	1-126-157-11	ELECT 10MF 20% 16V	
C421	1-102-125-00	CERAMIC 0.0047MF 10% 50V	
C422	1-124-464-11	ELECT 0.22MF 20% 16V	
C423	1-126-157-11	ELECT 10MF 20% 16V	
C424	1-126-157-11	ELECT 10MF 20% 16V	
C425	1-108-634-11	MYLAR 0.047MF 10% 100V	
C426	1-128-499-11	ELECT 220MF 20% 16V	
C427	1-128-499-11	ELECT 220MF 20% 16V	
C428	1-128-499-11	ELECT 220MF 20% 16V	
C429	1-124-234-00	ELECT 22MF 20% 16V	
C430	1-163-033-00	CERAMIC CHIP 0.022MF 50V	
C438	1-124-234-00	ELECT 22MF 20% 16V	
C439	1-163-033-00	CERAMIC CHIP 0.022MF 50V	
C440	1-163-033-00	CERAMIC CHIP 0.022MF 50V	
C441	1-124-234-00	ELECT 22MF 20% 16V	
C442	1-163-033-00	CERAMIC CHIP 0.022MF 50V	

REF. NO.	PART NO.	DESCRIPTION	REMARK	REF. NO.	PART NO.	DESCRIPTION	REMARK
C443	1-163-033-00	CERAMIC CHIP 0.022MF	50V	Q405	8-729-901-01	TRANSISTOR D7C144EK	
C444	1-163-033-00	CERAMIC CHIP 0.022MF	50V	Q406	8-729-920-74	TRANSISTOR 25C2412X-QR	
C445	1-163-031-11	CERAMIC CHIP 0.01MF	50V	Q407	8-729-920-74	TRANSISTOR 25C2412X-QR	
C447	1-163-031-11	CERAMIC CHIP 0.01MF	50V	Q409	8-729-920-74	TRANSISTOR 25C2412X-QR	
C448	1-124-234-00	ELECT 22MF	20% 16V	Q410	8-729-920-74	TRANSISTOR 25C2412X-QR	
C449	1-124-234-00	ELECT 22MF	20% 16V	Q412	8-729-216-22	TRANSISTOR 25A1162-G	
C450	1-124-234-00	ELECT 22MF	20% 16V	Q414	8-729-216-22	TRANSISTOR 25A1162-G	
C451	1-163-033-00	CERAMIC CHIP 0.022MF	50V	Q416	8-729-145-18	TRANSISTOR 25C3736	
C452	1-128-499-11	ELECT 220MF	20% 16V	Q417	8-729-901-06	TRANSISTOR D7A144EK	
C453	1-128-499-11	ELECT 220MF	20% 16V	Q418	8-729-920-74	TRANSISTOR 25C2412X-QR	
C454	1-126-301-11	ELECT 1MF	20% 50V	Q419	8-729-901-06	TRANSISTOR D7A144EK	
C455	1-126-301-11	ELECT 1MF	20% 50V	Q420	8-729-901-06	TRANSISTOR D7A144EK	
C456	1-126-301-11	ELECT 1MF	20% 50V	Q425	8-729-901-01	TRANSISTOR D7C144EK	
C458	1-163-031-11	CERAMIC CHIP 0.01MF	50V			<RESISTOR>	
C459	1-163-038-00	CERAMIC CHIP 0.1MF	25V	JR401	1-216-296-00	METAL GLAZE 0 5% 1/8W	
C460	1-163-038-00	CERAMIC CHIP 0.1MF	25V	JR402	1-216-296-00	METAL GLAZE 0 5% 1/8W	
		<CONNECTOR>		JR403	1-216-296-00	METAL GLAZE 0 5% 1/8W	
CN401	*1-506-492-11	PIN, CONNECTOR 13P		JR404	1-216-296-00	METAL GLAZE 0 5% 1/8W	
CN402	*1-564-518-11	PLUG, CONNECTOR 3P		JR406	1-216-296-00	METAL GLAZE 0 5% 1/8W	
CN403	*1-580-690-11	PIN, CONNECTOR (PC BOARD) 4P		JR407	1-216-296-00	METAL GLAZE 0 5% 1/8W	
CN404	*1-564-519-11	PLUG, CONNECTOR 4P		JR408	1-216-296-00	METAL GLAZE 0 5% 1/8W	
		<DIODE>		JR409	1-216-296-00	METAL GLAZE 0 5% 1/8W	
D403	8-719-110-09	DIODE R08.2ESB3		JR410	1-216-296-00	METAL GLAZE 0 5% 1/8W	
D404	8-719-404-46	DIODE M110		JB411	1-216-296-00	METAL GLAZE 0 5% 1/8W	
D405	8-719-404-46	DIODE M110		JR412	1-216-296-00	METAL GLAZE 0 5% 1/8W	
D408	8-719-404-46	DIODE M110		JR413	1-216-296-00	METAL GLAZE 0 5% 1/8W	
D409	8-719-404-46	DIODE M110		JR414	1-216-296-00	METAL GLAZE 0 5% 1/8W	
D410	8-719-404-46	DIODE M110		JR415	1-216-296-00	METAL GLAZE 0 5% 1/8W	
D411	8-719-404-46	DIODE M110		JR416	1-216-296-00	METAL GLAZE 0 5% 1/8W	
D412	8-719-404-46	DIODE M110		JR417	1-216-296-00	METAL GLAZE 0 5% 1/8W	
D413	8-719-404-46	DIODE M110		JR419	1-216-296-00	METAL GLAZE 0 5% 1/8W	
D414	8-719-404-46	DIODE M110		JR422	1-216-296-00	METAL GLAZE 0 5% 1/8W	
D415	8-719-404-46	DIODE M110		JR424	1-216-296-00	METAL GLAZE 0 5% 1/8W	
D416	8-719-404-46	DIODE M110		JR425	1-216-296-00	METAL GLAZE 0 5% 1/8W	
D417	8-719-404-46	DIODE M110		JR426	1-216-296-00	METAL GLAZE 0 5% 1/8W	
D418	8-719-404-46	DIODE M110		JR427	1-216-296-00	METAL GLAZE 0 5% 1/8W	
D419	8-719-404-46	DIODE M110		JR428	1-216-296-00	METAL GLAZE 0 5% 1/8W	
D420	8-719-404-46	DIODE M110		JR430	1-216-296-00	METAL GLAZE 0 5% 1/8W	
D421	8-719-404-46	DIODE M110		JR431	1-216-296-00	METAL GLAZE 0 5% 1/8W	
D422	8-719-404-46	DIODE M110		JR432	1-216-296-00	METAL GLAZE 0 5% 1/8W	
D423	8-719-404-46	DIODE M110		JR434	1-216-296-00	METAL GLAZE 0 5% 1/8W	
D424	8-719-404-46	DIODE M110		JR436	1-216-296-00	METAL GLAZE 0 5% 1/8W	
D425	8-719-404-46	DIODE M110		JR437	1-216-296-00	METAL GLAZE 0 5% 1/8W	
		<IC>		JR438	1-216-296-00	METAL GLAZE 0 5% 1/8W	
IC402	8-759-501-21	IC MN1497F		JR439	1-216-296-00	METAL GLAZE 0 5% 1/8W	
IC403	8-759-420-04	IC AN5265		JR440	1-216-296-00	METAL GLAZE 0 5% 1/8W	
		<COIL>		JR441	1-216-296-00	METAL GLAZE 0 5% 1/8W	
L401	1-410-682-31	INDUCTOR 470UH		R401	1-214-702-00	METAL 75 1%	
L402	1-410-682-31	INDUCTOR 470UH		R402	1-216-049-00	METAL GLAZE 1K 5% 1/10W	
		<TRANSISTOR>		R403	1-216-091-00	METAL GLAZE 56K 5% 1/10W	
Q401	8-729-216-22	TRANSISTOR 25A1162-G		R404	1-216-093-00	METAL GLAZE 68K 5% 1/10W	
Q402	8-729-901-06	TRANSISTOR D7A144EK		R405	1-216-061-00	METAL GLAZE 3.3K 5% 1/10W	
Q403	8-729-901-06	TRANSISTOR D7A144EK		R416	1-216-029-00	METAL GLAZE 150 5% 1/10W	
Q404	8-729-901-06	TRANSISTOR D7A144EK		R418	1-216-089-00	METAL GLAZE 47K 5% 1/10W	
				R419	1-216-089-00	METAL GLAZE 47K 5% 1/10W	
				R420	1-216-089-00	METAL GLAZE 47K 5% 1/10W	
				R421	1-216-097-00	METAL GLAZE 100K 5% 1/10W	
				R422	1-216-089-00	METAL GLAZE 47K 5% 1/10W	
				R429	1-214-702-00	METAL 75 1%	1/4W
				R430	1-216-049-00	METAL GLAZE 1K 5%	1/10W

QB

CB

D

REF. NO.	PART NO.	DESCRIPTION	REMARK
R431	1-216-093-00	METAL GLAZE 68K 5%	1/10W
R432	1-216-091-00	METAL GLAZE 56K 5%	1/10W
R433	1-216-061-00	METAL GLAZE 3.3K 5%	1/10W
R434	1-216-027-00	METAL GLAZE 120 5%	1/10W
R435	1-214-702-00	METAL 75 1%	1/4W
R436	1-216-049-00	METAL GLAZE 1K 5%	1/10W
R437	1-216-093-00	METAL GLAZE 68K 5%	1/10W
R438	1-216-091-00	METAL GLAZE 56K 5%	1/10W
R439	1-216-061-00	METAL GLAZE 3.3K 5%	1/10W
R440	1-216-027-00	METAL GLAZE 120 5%	1/10W
R444	1-214-702-00	METAL 75 1%	1/4W
R445	1-216-049-00	METAL GLAZE 1K 5%	1/10W
R446	1-216-093-00	METAL GLAZE 68K 5%	1/10W
R447	1-216-091-00	METAL GLAZE 56K 5%	1/10W
R448	1-216-061-00	METAL GLAZE 3.3K 5%	1/10W
R449	1-216-027-00	METAL GLAZE 120 5%	1/10W
R450	1-214-702-00	METAL 75 1%	1/4W
R451	1-216-049-00	METAL GLAZE 1K 5%	1/10W
R452	1-216-093-00	METAL GLAZE 68K 5%	1/10W
R453	1-216-091-00	METAL GLAZE 56K 5%	1/10W
R454	1-216-061-00	METAL GLAZE 3.3K 5%	1/10W
R455	1-216-037-00	METAL GLAZE 330 5%	1/10W
R456	1-216-089-00	METAL GLAZE 47K 5%	1/10W
R457	1-216-113-00	METAL GLAZE 470K 5%	1/10W
R458	1-216-089-00	METAL GLAZE 47K 5%	1/10W
R459	1-216-089-00	METAL GLAZE 47K 5%	1/10W
R460	1-216-089-00	METAL GLAZE 47K 5%	1/10W
R461	1-216-097-00	METAL GLAZE 100K 5%	1/10W
R462	1-216-115-00	METAL GLAZE 560K 5%	1/10W
R463	1-216-105-00	METAL GLAZE 220K 5%	1/10W
R464	1-216-077-00	METAL GLAZE 15K 5%	1/10W
R465	1-216-025-00	METAL GLAZE 190 5%	1/10W
R466	1-216-089-00	METAL GLAZE 47K 5%	1/10W
R467	1-216-073-00	METAL GLAZE 10K 5%	1/10W
R471	1-216-097-00	METAL GLAZE 100K 5%	1/10W
R472	1-216-115-00	METAL GLAZE 560K 5%	1/10W
R473	1-216-105-00	METAL GLAZE 220K 5%	1/10W
R474	1-216-077-00	METAL GLAZE 15K 5%	1/10W
R475	1-216-025-00	METAL GLAZE 190 5%	1/10W
R477	1-216-073-00	METAL GLAZE 10K 5%	1/10W
R478	1-216-097-00	METAL GLAZE 2.2K 5%	1/10W
R479	1-216-085-00	METAL GLAZE 33K 5%	1/10W
R480	1-247-711-11	CARBON 680 5%	1/4W
R481	1-216-063-00	METAL GLAZE 3.3K 5%	1/10W
R482	1-249-455-11	CARBON 4.7 5%	1/4W
R483	1-249-389-11	CARBON 4.7 5%	1/4W F
R484	1-216-041-00	METAL GLAZE 470 5%	1/10W F
R485	1-247-688-11	CARBON 10 5%	1/4W F
R486	1-249-468-11	CARBON 82K 5%	1/4W
R487	1-249-468-11	CARBON 82K 5%	1/4W
<VARIABLE RESISTOR>			
RV401	1-230-481-11	RES. VAR. CARBON 20K	
<SWITCH>			
S401	1-570-145-11	SWITCH, SLIDE	
S402	1-570-145-11	SWITCH, SLIDE	

+1-644-019-11	CB BOARD	*****	

REF. NO.	PART NO.	DESCRIPTION	REMARK
	1-526-958-11	SOCKET, CRT	
<CAPACITOR>			
C701	1-162-114-00	CERAMIC 0.0047MF	10% 2KV
C702	1-161-830-00	CERAMIC 0.0047MF	99% 500V
C705	1-124-798-11	ELECT 1MF	20% 160V
C704	1-162-123-00	CERAMIC 0.0033MF	10% 50V
<CONNECTOR>			
CN701	*1-564-509-11	PLUG, CONNECTOR 6P	
CN702	*1-508-784-00	PIN, CONNECTOR (5MM PITCH) 1P	
CN703	*1-564-508-11	PLUG, CONNECTOR 5P	
<DIODE>			
D701	8-719-300-33	DIODE RU-3AM	
<COIL>			
L701	1-410-668-11	INDUCTOR 27UH	
<RESISTOR>			
R701	1-202-822-00	SOLID 2.2K 20%	1/2W
R702	1-202-822-00	SOLID 2.2K 20%	1/2W
R703	1-202-822-00	SOLID 2.2K 20%	1/2W
R704	1-202-835-00	SOLID 39K 20%	1/2W
R705	1-202-838-00	SOLID 100K 20%	1/2W
R706	1-202-731-00	SOLID 10M 20%	1/2W
R707	1-202-842-11	SOLID 220K 20%	1/2W

#A-1341-562-A D BOARD, COMPLETE *****			
#3-738-015-01 COVER, (DIA. 6) CARBON VR			
4-382-854-01 SCREW (M3X8), P, SW (+)			

<CAPACITOR>			
C501	1-124-477-11	ELECT 47MF	20% 16V
C502	1-124-907-11	ELECT 10MF	20% 50V
C503	1-126-103-11	ELECT 470PF	20% 16V
C504	1-124-902-00	ELECT 0.47MF	20% 50V
C505	1-106-381-12	MYLAR 0.039MF	10% 100V
C506	1-124-903-11	ELECT 1MF	20% 50V
C507	1-106-367-00	MYLAR 0.01MF	10% 100V
C508	1-124-903-11	ELECT 1MF	20% 50V
C509	1-136-173-00	FILM 0.47MF	5% 50V
C510	1-136-161-00	FILM 0.047MF	5% 50V
C511	1-124-903-11	ELECT 1MF	20% 50V
C512	1-106-375-12	MYLAR 0.022MF	10% 100V
C513	1-106-375-12	MYLAR 0.022MF	10% 100V
C514	1-106-371-00	MYLAR 0.015MF	10% 100V
C515	1-124-925-11	ELECT 2.2MF	20% 50V
C516	1-124-925-11	ELECT 2.2MF	20% 50V
C517	1-130-480-00	FILM 0.0056MF	5% 50V
C518	1-163-245-11	CERAMIC CHIP 56PF	5% 50V
C519	1-124-927-11	ELECT 4.7MF	20% 50V
C520	1-163-129-00	CERAMIC CHIP 330PF	5% 50V
C521	1-124-907-11	ELECT 10MF	20% 50V
C523	1-106-363-00	MYLAR 0.0068MF	10% 100V

REF. NO.	PART NO.	DESCRIPTION	REMARK	REF. NO.	PART NO.	DESCRIPTION	REMARK
C524	1-102-116-00	CERAMIC	680PF	10%	50V		
C525	1-102-820-00	CERAMIC	330PF	5%	50V		
C526	1-102-973-00	CERAMIC	100PF	5%	50V		
C527	1-124-514-11	ELECT	100MF	20%	50V		
C528	1-102-125-00	CERAMIC	0.0047MF	10%	50V		
C529	1-124-513-11	ELECT	47MF	20%	50V		
C530	1-163-097-00	CERAMIC CHIP	15PF	5%	50V		
C531	1-131-370-00	TANTALUM	6.8MF	10%	16V		
C532	1-124-557-11	ELECT	1000MF	20%	25V		
C533	1-124-927-11	ELECT	4.7MF	20%	50V		
C534	1-124-768-11	ELECT	4.7MF	20%	50V		
C535	1-136-161-00	FILM	0.047MF	5%	50V		
C536	1-124-927-11	ELECT	4.7MF	20%	50V		
C537	1-124-510-11	ELECT	220MF	20%	35V		
C538	1-124-910-11	ELECT	47MF	20%	50V		
C539	1-136-828-11	FILM	1.8MF	5%	200V		
C540	1-163-017-00	CERAMIC CHIP	0.0047MF	10%	50V		
C541	1-163-035-00	CERAMIC CHIP	0.047MF	50V			
C542	1-126-103-11	ELECT	470MF	20%	16V		
C545	1-126-101-11	ELECT	100MF	20%	16V		
C546	1-124-907-11	ELECT	10MF	20%	50V		
C547	1-124-907-11	ELECT	10MF	20%	50V		
C548	1-124-907-11	ELECT	10MF	20%	50V		
C549	1-124-907-11	ELECT	10MF	20%	50V		
C550	1-124-907-11	ELECT	10MF	20%	50V		
C551	1-124-927-11	ELECT	4.7MF	20%	50V		
C552	1-101-004-00	CERAMIC	0.01MF	50V			
C553	1-126-103-11	ELECT	470MF	20%	16V		
C553	1-106-383-00	MYLAR	0.047MF	10%	100V		
C564	1-163-009-11	CERAMIC CHIP	0.001MF	10%	50V		
C567	1-123-875-11	ELECT	10MF	20%	50V		
C568	1-130-736-11	FILM	0.01MF	5%	50V		
C569	1-130-471-00	FILM	0.001MF	5%	50V		
C570	1-163-117-00	CERAMIC CHIP	100PF	5%	50V		
C571	1-124-913-11	ELECT	470MF	20%	50V		
C572	1-101-004-00	CERAMIC	0.01MF	50V			
C574	1-106-351-00	MYLAR	0.0022MF	10%	100V		
C575	1-106-351-00	MYLAR	0.0022MF	10%	100V		
C831	1-123-875-11	ELECT	10MF	20%	50V		
C832	1-123-875-11	ELECT	10MF	20%	50V		
C833	1-163-009-11	CERAMIC CHIP	0.001MF	10%	50V		
C834	1-163-121-00	CERAMIC CHIP	150PF	5%	50V		
C835	1-163-209-00	CERAMIC CHIP	0.0015MF	5%	50V		
C836	1-123-875-11	ELECT	10MF	20%	50V		
C837	1-163-209-00	CERAMIC CHIP	0.0015MF	5%	50V		
C838	1-136-163-00	FILM	0.068MF	5%	50V		
C839	1-102-122-00	CERAMIC	0.0027MF	10%	50V		
C840	1-163-209-00	CERAMIC CHIP	0.0015MF	5%	50V		
C841	1-163-209-00	CERAMIC CHIP	0.0015MF	5%	50V		
C843	1-124-042-51	ELECT	0.47MF	20%	50V		
C844	1-124-902-00	ELECT	0.47MF	20%	50V		
C845	1-124-126-00	ELECT	47MF	20%	10V		
C846	1-124-907-11	ELECT	10MF	20%	50V		
C847	1-126-233-11	ELECT	22MF	20%	50V		
C848	1-131-351-00	TANTALUM	4.7MF	10%	35V		
C849	1-164-182-11	CERAMIC CHIP	0.0033MF	10%	50V		
C1601	1-124-907-11	ELECT	10MF	20%	50V		
C1602	1-164-161-11	CERAMIC CHIP	0.0022MF	10%	50V		
C1603	1-104-248-01	ELECT	15MF	20%	50V		
C1604	1-128-500-51	ELECT	1000MF	20%	50V		
C1605	1-124-922-11	ELECT	1000MF	20%	50V		
C1606	1-163-009-11	CERAMIC CHIP	0.001MF	10%	50V		
C1607	1-124-907-11	ELECT	10MF	20%	50V		
C1608	1-126-233-11	ELECT	22MF	20%	50V		
C1609	1-163-009-11	CERAMIC CHIP	0.001MF	10%	50V		
C1610	1-126-163-11	ELECT	4.7MF	20%	50V		
C1611	1-124-482-11	ELECT	33MF	20%	35V		
C1612	1-136-257-00	FILM	0.0039MF	5%	50V		
C1613	1-163-009-11	CERAMIC CHIP	0.001MF	10%	50V		
C1614	1-164-232-11	CERAMIC CHIP	0.01MF	10%	50V		
C1615	1-124-042-51	ELECT	0.47MF	20%	50V		
C1620	1-163-133-00	CERAMIC CHIP	470PF	5%	50V		
C1621	1-163-117-00	CERAMIC CHIP	100PF	5%	50V		
C1641	1-163-035-00	CERAMIC CHIP	0.047MF	50V			
<CONNECTOR>							
CN501	*1-564-506-11	PLUG, CONNECTOR 3P					
CN502	*1-506-477-11	PIN, CONNECTOR 12P					
CN504	*1-564-507-11	PLUG, CONNECTOR 4P					
CN505	*1-564-509-11	PLUG, CONNECTOR 6P					
CN507	*1-564-507-11	PLUG, CONNECTOR 4P					
CN508	*1-564-104-00	PIN, CONNECTOR (BSP-VH) 3P					
CN509	*1-564-506-11	PLUG, CONNECTOR 3P					
<DIODE>							
D501	8-719-404-46	DIODE MA110					
D502	8-719-404-46	DIODE MA110					
D503	8-719-404-46	DIODE MA110					
D504	8-719-404-46	DIODE MA110					
D505	8-719-404-46	DIODE MA110					
D506	8-719-911-55	DIODE D05G					
D507	8-719-404-46	DIODE MA110					
D508	8-719-404-46	DIODE MA110					
D509	8-719-404-46	DIODE MA110					
D510	8-719-404-46	DIODE MA110					
D511	8-719-404-46	DIODE MA110					
D512	8-719-404-46	DIODE MA110					
D514	8-719-404-46	DIODE MA110					
D579	8-719-800-81	DIODE 1S5226					
D831	8-719-404-46	DIODE MA110					
D832	8-719-404-46	DIODE MA110					
D833	8-719-404-46	DIODE MA110					
D834	8-719-404-46	DIODE MA110					
D835	8-719-109-89	DIODE RD5.6ESB2					
D836	8-719-977-69	DIODE DT224B					
D837	8-719-404-46	DIODE MA110					
D838	8-719-404-46	DIODE MA110					
D1601	8-719-105-XX	DIODE RD6.2M-81					
D1602	8-719-404-46	DIODE MA110					
D1603	8-719-977-61	DIODE DT220B					
D1604	8-719-404-46	DIODE MA110					
D1605	8-719-404-46	DIODE MA110					
D1606	8-719-581-00	DIODE ERC81-004					
D1607	8-719-581-00	DIODE ERC81-004					
D1608	8-719-577-02	DIODE DT25.6A					
D1609	8-719-977-49	DIODE DT215B					
D1610	8-719-404-46	DIODE MA110					
D1611	8-729-101-31	TRANSISTOR N1371					
D1612	8-719-404-46	DIODE MA110					
D1613	8-719-404-46	DIODE MA110					
D1614	8-719-404-46	DIODE MA110					
D1615	8-719-404-46	DIODE MA110					
D1616	8-719-404-46	DIODE MA110					
D1617	8-719-977-49	DIODE DT215B					
D1618	8-719-977-49	DIODE DT215B					
D1625	8-719-404-46	DIODE MA110					

D

Les composants identifiés par une trame et une marque Δ sont critiques pour la sécurité. Ne les remplacer que par une pièce portant le numéro spécifique.

The components identified by shading and mark Δ are critical for safety. Replace only with part number specified.

REF. NO.	PART NO.	DESCRIPTION	REMARK	REF. NO.	PART NO.	DESCRIPTION	REMARK
D1626	8-719-404-46	DIODE MA110		Q1605	8-729-119-80	TRANSISTOR 2SC2688-LK	
D1627	8-719-404-46	DIODE MA110		Q1606	8-729-135-42	TRANSISTOR 2SC2334-L	
D1628	8-719-404-46	DIODE MA110		Q1607	8-729-920-74	TRANSISTOR 2SC2412K-QR	
D1635	8-719-404-46	DIODE MA110		Q1608	8-729-920-74	TRANSISTOR 2SC2412K-QR	
D1699	8-719-404-46	DIODE MA110		Q1609	8-729-920-74	TRANSISTOR 2SC2412K-QR	
<FUSE>				Q1610	8-729-920-74	TRANSISTOR 2SC2412K-QR	
F1601A	1-532-777-21	FUSE, MICRO (SECONDARY) (1.25A/125V)		Q1611	8-729-920-74	TRANSISTOR 2SC2412K-QR	
F1602	1-533-189-11	HOLDER, FUSE		Q1612	8-729-920-74	TRANSISTOR 2SC2412K-QR	
<IC>				Q1613	8-729-920-74	TRANSISTOR 2SC2412K-QR	
IC501	8-759-909-70	IC CX23025		Q1614	8-729-920-74	TRANSISTOR 2SC2412K-QR	
IC502	8-759-100-60	IC UPC1377C		Q1615	8-729-216-22	TRANSISTOR 2SA1162-G	
IC503	8-759-801-98	IC LA7830		Q1616	8-729-216-22	TRANSISTOR 2SA1162-G	
IC504	8-759-929-62	IC LM7812CT		Q1617	8-729-216-22	TRANSISTOR 2SA1162-G	
IC505	8-759-009-51	IC MC145388F		Q1618	8-729-216-22	TRANSISTOR 2SA1162-G	
IC831	8-759-509-29	IC XR40118F		<RESISTOR>			
IC832	8-759-509-37	IC XR40708F		JR510	1-216-295-00	METAL GLAZE	0 5% 1/10W
IC833	8-759-009-51	IC MC145388F		R501	1-216-089-00	METAL GLAZE	47K 5% 1/10W
IC1601	8-759-509-91	IC XR410393F		R502	1-216-089-00	METAL GLAZE	47K 5% 1/10W
<COIL>				R503	1-249-437-11	CARBON	47K 5% 1/4W F
L501	1-410-093-11	INDUCTOR 33MH		R504	1-216-073-00	METAL GLAZE	10K 5% 1/10W
L502	1-410-665-31	INDUCTOR 15UH		R505	1-249-393-11	CARBON	10 5% 1/4W F
L503	1-424-625-11	COIL, CHOKER (PMC) 381.4UH		R506	1-216-071-00	METAL GLAZE	8.2K 5% 1/10W
L506	1-412-530-31	INDUCTOR 27UH		R507	1-216-059-00	METAL GLAZE	2.7K 5% 1/10W
L1601	1-459-155-00	COIL (WITH CORE) 45UH		R508	1-216-085-00	METAL GLAZE	33K 5% 1/10W
L1602	1-424-626-12	COIL, CHOKER 390UH		R509	1-216-687-11	METAL CHIP	33K 0.50% 1/10W
L1603	1-410-397-21	FERRITE BEAD INDUCTOR		R510	1-216-683-11	METAL CHIP	22K 0.50% 1/10W
<TRANSISTOR>				R511	1-216-675-11	METAL CHIP	10K 0.50% 1/10W
Q501	8-729-901-01	TRANSISTOR DTC144EK		R512	1-218-751-11	METAL CHIP	240K 0.50% 1/10W
Q502	8-729-901-01	TRANSISTOR DTC144EK		R513	1-216-065-00	METAL GLAZE	4.7K 5% 1/10W
Q503	8-729-901-06	TRANSISTOR DTA144EK		R514	1-218-754-11	METAL CHIP	120K 0.50% 1/10W
Q504	8-729-901-01	TRANSISTOR DTC144EK		R515	1-216-081-00	METAL GLAZE	22K 5% 1/10W
Q505	8-729-920-74	TRANSISTOR 2SC2412K-QR		R516	1-216-073-00	METAL GLAZE	10K 5% 1/10W
Q506	8-729-901-01	TRANSISTOR DTC144EK		R517	1-218-768-11	METAL CHIP	470K 0.50% 1/10W
Q507	8-729-901-01	TRANSISTOR DTC144EK		R518	1-249-422-11	CARBON	2.7K 5% 1/4W F
Q508	8-729-920-74	TRANSISTOR 2SC2412K-QR		R519	1-216-085-00	METAL GLAZE	33K 5% 1/10W
Q509	8-729-920-74	TRANSISTOR 2SC2412K-QR		R520	1-216-677-11	METAL CHIP	12K 0.50% 1/10W
Q510	8-729-901-06	TRANSISTOR DTA144EK		R521	1-216-067-00	METAL GLAZE	5.6K 5% 1/10W
Q511	8-729-901-01	TRANSISTOR DTC144EK		R522	1-216-107-00	METAL GLAZE	270K 5% 1/10W
Q512	8-729-920-74	TRANSISTOR 2SC2412K-QR		R523	1-216-081-00	METAL GLAZE	22K 5% 1/10W
Q513	8-729-216-22	TRANSISTOR 2SA1162-G		R524	1-216-049-00	METAL GLAZE	1K 5% 1/10W
Q514	8-729-216-22	TRANSISTOR 2SA1162-G		R525	1-216-434-11	METAL OXIDE	1.8K 5% 1W F
Q515	8-729-313-42	TRANSISTOR 2SD1134-C		R526	1-216-079-00	METAL GLAZE	18K 5% 1/10W
Q516	8-729-901-01	TRANSISTOR DTC144EK		R527	1-249-437-11	CARBON	47K 5% 1/4W F
Q517	8-729-901-01	TRANSISTOR DTC144EK		R528	1-216-073-00	METAL GLAZE	10K 5% 1/10W
Q518	8-729-920-74	TRANSISTOR 2SC2412K-QR		R529	1-216-073-00	METAL GLAZE	10K 5% 1/10W
Q519	8-729-920-74	TRANSISTOR 2SC2412K-QR		R530	1-216-089-00	METAL GLAZE	47K 5% 1/10W
Q525	8-729-920-74	TRANSISTOR 2SC2412K-QR		R531	1-216-089-00	METAL GLAZE	47K 5% 1/10W
Q532	8-729-920-74	TRANSISTOR 2SC2412K-QR		R532	1-216-097-00	METAL GLAZE	100K 5% 1/10W
Q533	8-729-920-74	TRANSISTOR 2SC2412K-QR		R533	1-216-085-00	METAL GLAZE	47K 5% 1/10W
Q833	8-729-216-22	TRANSISTOR 2SA1162-G		R534	1-216-097-00	METAL GLAZE	100K 5% 1/10W
Q834	8-729-920-74	TRANSISTOR 2SC2412K-QR		R535	1-216-053-00	METAL GLAZE	1.5K 5% 1/10W
Q835	8-729-920-74	TRANSISTOR 2SC2412K-QR		R536	1-212-881-11	FUSIBLE	100 5% 1/4W F
Q836	8-729-309-08	TRANSISTOR 2SC1890A-E		R537	1-215-867-00	METAL OXIDE	47K 5% 1W F
Q1601	8-729-920-74	TRANSISTOR 2SC2412K-QR		R538	1-216-095-00	METAL GLAZE	82K 5% 1/10W
Q1602	8-729-920-74	TRANSISTOR 2SC2412K-QR		R539	1-216-095-00	METAL GLAZE	82K 5% 1/10W
Q1603	8-729-920-74	TRANSISTOR 2SC2412K-QR		R540	1-216-101-00	METAL GLAZE	150K 5% 1/10W
Q1604	8-729-216-22	TRANSISTOR 2SA1162-G		R541	1-216-063-00	METAL GLAZE	3.9K 5% 1/10W
				R542	1-216-075-00	METAL GLAZE	12K 5% 1/10W
				R543	1-216-065-00	METAL GLAZE	4.7K 5% 1/10W
				R544	1-216-101-00	METAL GLAZE	150K 5% 1/10W
				R545	1-216-041-00	METAL GLAZE	470 5% 1/10W

REF. NO.	PART NO.	DESCRIPTION	REMARK	REF. NO.	PART NO.	DESCRIPTION	REMARK
R546	1-216-091-00	METAL GLAZE	56K 5%	1/10W	R1503	1-216-049-00	METAL GLAZE 1K 5% 1/10W
R547	1-216-121-00	METAL GLAZE	1K 5%	1/10W	R1504	1-216-689-11	METAL CHIP 39K 0.50% 1/10W
R548	1-216-107-00	METAL GLAZE	270K 5%	1/10W	R1505	1-216-089-00	METAL GLAZE 47K 5% 1/10W
R549	1-216-101-00	METAL GLAZE	150K 5%	1/10W	R1506	1-216-667-11	METAL CHIP 4.7K 0.50% 1/10W
R550	1-216-354-11	METAL OXIDE	2.7 5%	3W F	R1507	1-216-081-00	METAL GLAZE 22K 5% 1/10W
R552	1-216-061-00	METAL GLAZE	3.3K 5%	1/10W	R1508	1-216-073-00	METAL GLAZE 10K 5% 1/10W
R553	1-216-091-00	METAL GLAZE	56K 5%	1/10W	R1509	1-216-065-00	METAL GLAZE 4.7K 5% 1/10W
R554	1-216-073-00	METAL GLAZE	10K 5%	1/10W	R1510	1-249-425-11	CARBON 4.7K 5% 1/4W F
R555	1-216-077-00	METAL GLAZE	15K 5%	1/10W	R1511	1-216-033-00	METAL GLAZE 220 5% 1/10W
R557	1-216-057-00	METAL GLAZE	2.2K 5%	1/10W	R1512	1-216-049-00	METAL GLAZE 1K 5% 1/10W
R558	1-216-049-00	METAL GLAZE	1K 5%	1/10W	R1513	1-216-017-00	METAL GLAZE 47 5% 1/10W
R559	1-216-065-00	METAL GLAZE	4.7K 5%	1/10W	R1519	1-216-031-00	METAL GLAZE 180 5% 1/10W
R560	1-216-037-00	METAL GLAZE	330 5%	1/10W	R1520	1-216-057-00	METAL GLAZE 2.2K 5% 1/10W
R561	1-216-085-00	METAL GLAZE	33K 5%	1/10W	R1601	1-216-685-11	METAL CHIP 27K 0.50% 1/10W
R562	1-216-057-00	METAL GLAZE	2.2K 5%	1/10W	R1602	1-216-681-11	METAL CHIP 18K 0.50% 1/10W
R563	1-216-065-00	METAL GLAZE	4.7K 5%	1/10W	R1603	1-216-671-11	METAL CHIP 6.8K 0.50% 1/10W
R564	1-249-410-11	CARBON	270 5%	1/4W F	R1604	1-249-433-11	CARBON 22K 5% 1/4W F
R565	1-216-059-00	METAL GLAZE	2.7K 5%	1/10W	R1605	1-216-070-00	METAL GLAZE 7.5K 5% 1/10W
R566	1-216-025-00	METAL GLAZE	100 5%	1/10W	R1606	1-216-070-00	METAL GLAZE 7.5K 5% 1/10W
R567	1-216-095-00	METAL GLAZE	82K 5%	1/10W	R1607	1-216-071-00	METAL GLAZE 8.2K 5% 1/10W
R568	1-216-063-00	METAL GLAZE	3.9K 5%	1/10W	R1608	1-216-065-00	METAL GLAZE 4.7K 5% 1/10W
R569	1-216-063-00	METAL GLAZE	3.9K 5%	1/10W	R1609	1-216-069-00	METAL GLAZE 6.8K 5% 1/10W
R570	1-216-093-00	METAL GLAZE	68K 5%	1/10W	R1610	1-216-057-00	METAL GLAZE 2.2K 5% 1/10W
R571	1-216-089-00	METAL GLAZE	47K 5%	1/10W	R1611	1-216-057-00	METAL GLAZE 2.2K 5% 1/10W
R572	1-216-095-00	METAL GLAZE	82K 5%	1/10W	R1612	1-215-913-11	METAL OXIDE 220 5% 3W F
R573	1-216-063-00	METAL GLAZE	3.9K 5%	1/10W	R1613	1-216-025-00	METAL GLAZE 100 5% 1/10W
R574	1-216-063-00	METAL GLAZE	3.9K 5%	1/10W	R1614	1-216-067-00	METAL GLAZE 5.6K 5% 1/10W
R575	1-216-105-00	METAL GLAZE	220K 5%	1/10W	R1615	1-216-657-11	METAL CHIP 1.8K 0.50% 1/10W
R576	1-216-109-00	METAL GLAZE	330K 5%	1/10W	R1616	1-216-625-11	METAL CHIP 120 0.50% 1/10W
R577	1-216-105-00	METAL GLAZE	220K 5%	1/10W	R1617	1-216-659-11	METAL CHIP 2.2K 0.50% 1/10W
R578	1-249-457-11	CARBON	6.8 5%	1/4W F	R1618	1-216-073-00	METAL GLAZE 10K 5% 1/10W
R579	1-249-457-11	CARBON	6.8 5%	1/4W F	R1620	1-216-065-00	METAL GLAZE 4.7K 5% 1/10W
R580	1-216-001-00	METAL GLAZE	10 5%	1/10W	R1621	1-216-073-00	METAL GLAZE 10K 5% 1/10W
R591	1-216-063-00	METAL GLAZE	3.9K 5%	1/10W	R1622	1-216-073-00	METAL GLAZE 10K 5% 1/10W
R592	1-216-033-00	METAL GLAZE	220 5%	1/10W	R1623	1-216-073-00	METAL GLAZE 10K 5% 1/10W
R831	1-216-048-00	METAL GLAZE	1K 5%	1/10W	R1624	1-216-246-00	METAL GLAZE 100K 5% 1/8W
R832	1-216-075-00	METAL GLAZE	12K 5%	1/10W	R1625	1-216-061-00	METAL GLAZE 3.3K 5% 1/10W
R833	1-216-065-00	METAL GLAZE	4.7K 5%	1/10W	R1626	1-216-065-00	METAL GLAZE 4.7K 5% 1/10W
R834	1-216-059-00	METAL GLAZE	2.7K 5%	1/10W	R1627	1-216-049-00	METAL GLAZE 1K 5% 1/10W
R835	1-216-081-00	METAL GLAZE	22K 5%	1/10W	R1628	1-216-073-00	METAL GLAZE 10K 5% 1/10W
R836	1-216-049-00	METAL GLAZE	1K 5%	1/10W	R1629	1-216-683-11	METAL CHIP 22K 0.50% 1/10W
R837	1-216-075-00	METAL GLAZE	12K 5%	1/10W	R1630	1-216-683-11	METAL CHIP 22K 0.50% 1/10W
R838	1-216-049-00	METAL GLAZE	1K 5%	1/10W	R1631	1-216-057-00	METAL GLAZE 2.2K 5% 1/10W
R839	1-216-061-00	METAL GLAZE	3.3K 5%	1/10W	R1632	1-216-042-00	METAL GLAZE 510 5% 1/10W
R840	1-216-097-00	METAL GLAZE	100K 5%	1/10W	R1633	1-216-109-00	METAL GLAZE 330K 5% 1/10W
R841	1-216-093-00	METAL GLAZE	68K 5%	1/10W	R1634	1-216-099-00	METAL GLAZE 120K 5% 1/10W
R842	1-216-093-00	METAL GLAZE	68K 5%	1/10W	R1635	1-216-097-00	METAL GLAZE 100K 5% 1/10W
R843	1-216-065-00	METAL GLAZE	4.7K 5%	1/10W	R1636	1-216-073-00	METAL GLAZE 10K 5% 1/10W
R844	1-216-077-00	METAL GLAZE	15K 5%	1/10W	R1640	1-216-063-00	METAL GLAZE 3.9K 5% 1/10W
R847	1-216-049-00	METAL GLAZE	1K 5%	1/10W	R1641	1-216-073-00	METAL GLAZE 10K 5% 1/10W
R850	1-216-085-00	METAL GLAZE	33K 5%	1/10W	R1642	1-216-073-00	METAL GLAZE 10K 5% 1/10W
R851	1-216-669-11	METAL CHIP	5.6K 0.50% 1/10W		R1643	1-216-069-00	METAL GLAZE 6.8K 5% 1/10W
R852	1-216-675-11	METAL CHIP	10K 0.50% 1/10W		R1644	1-216-069-00	METAL GLAZE 6.8K 5% 1/10W
R853	1-216-105-00	METAL GLAZE	220K 5%	1/10W	R1645	1-216-073-00	METAL GLAZE 10K 5% 1/10W
R854	1-218-754-11	METAL CHIP	120K 0.50% 1/10W		R1646	1-216-073-00	METAL GLAZE 10K 5% 1/10W
R855	1-216-697-11	METAL CHIP	82K 0.50% 1/10W		R1647	1-216-685-11	METAL CHIP 27K 0.50% 1/10W
R856	1-216-100-00	METAL CHIP	130K 0.50% 1/10W		R1648	1-216-069-00	METAL GLAZE 6.8K 5% 1/10W
R857	1-216-686-11	METAL CHIP	30K 0.50% 1/10W		R1649	1-216-069-00	METAL GLAZE 6.8K 5% 1/10W
R858	1-216-061-00	METAL GLAZE	3.3K 5%	1/10W	R1650	1-216-069-00	METAL GLAZE 6.8K 5% 1/10W
R859	1-216-436-00	METAL OXIDE	3.9K 5%	1W F	R1651	1-216-069-00	METAL GLAZE 6.8K 5% 1/10W
R860	1-216-679-11	METAL CHIP	15K 0.50% 1/10W		R1652	1-216-069-00	METAL GLAZE 6.8K 5% 1/10W
R861	1-216-672-11	METAL CHIP	7.5K 0.50% 1/10W		R1653	1-216-069-00	METAL GLAZE 6.8K 5% 1/10W
R862	1-216-675-11	METAL CHIP	10K 0.50% 1/10W		R1654	1-216-681-11	METAL CHIP 18K 0.50% 1/10W
R863	1-249-435-11	CARBON	33K 5%	1/4W F			

D	H _B	S
---	----------------	---

The components identified by **H** in this manual have been carefully factory-selected for each set in order to satisfy regulations regarding X-ray radiation. Should replacement be required, replace only with the value originally used.

Les composants identifiés par une lettre **H** en ce manuel ont été minutieusement sélectionnés pour chaque ensemble afin de satisfaire les réglementations relatives à la sécurité aux rayons X. En cas de remplacement, ne les remplacer que par une pièce portant le numéro spécifié.

The components identified by shading and mark **A** are critical for safety. Replace only with part number specified.

REF. NO.	PART NO.	DESCRIPTION	REMARK
R1655	1-216-081-00	METAL GLAZE 22K 5%	1/10W
R1656	1-216-643-11	METAL CHIP 470	0.50X 1/10W
R1657	1-216-081-00	METAL GLAZE 22K 5%	1/10W
R1658	1-216-063-00	METAL GLAZE 3.9K 5%	1/10W
R1659	1-216-049-00	METAL GLAZE 1K 5%	1/10W
R1660	1-216-649-11	METAL CHIP 820	0.50X 1/10W
R1661	1-216-065-00	METAL GLAZE 4.7K 5%	1/10W
<VARIABLE RESISTOR>			
RV501	1-238-019-11	RES. ADJ. CARBON 47K	
RV502	1-238-017-11	RES. ADJ. CARBON 22K	
RV503	1-241-763-11	RES. ADJ. CERMET 4.7X	
RV504	1-224-250-XX	RES. ADJ. METAL GLAZE 2.2K	
RV505	1-238-009-11	RES. ADJ. CARBON 220	
RV506	1-238-012-11	RES. ADJ. CARBON 1K	
RV507	1-238-013-11	RES. ADJ. CARBON 2.2K	
RV508	1-238-012-11	RES. ADJ. CARBON 1K	
RV509	1-238-020-11	RES. ADJ. CARBON 100X	
RV511	1-238-015-11	RES. ADJ. CARBON 4.7K	
RV512	1-238-015-11	RES. ADJ. CARBON 4.7K	
RV514	1-238-019-11	RES. ADJ. CARBON 47K	
RV515	1-238-021-11	RES. ADJ. CARBON 220K	
RV516	1-241-763-11	RES. ADJ. CERMET 4.7K	
RV831	1-228-997-00	RES. ADJ. METAL GLAZE 100K	
RV832	1-241-764-11	RES. ADJ. CERMET 10X	
RV833	1-228-997-11	RES. ADJ. METAL GLAZE	
RV1601	1-241-762-11	RES. ADJ. CERMET 2.2K	
RV1602	1-238-012-11	RES. ADJ. CARBON 1K	
RV1603	1-241-704-11	RES. ADJ. CERMET	
<RELAY>			
RY1601	1-515-481-21	RELAY (G2R-212P-V)	
<TRANSFORMER>			
T1601	1-437-216-11	TRANSFORMER, DRIVE	
<THERMISTOR>			
TH501	1-807-971-11	THERMISTOR	

#1-644-020-11	HB BOARD	*****	
#4-341-751-01	EYELET EYT		
#4-348-208-00	HOLDER, LED		
<CONNECTOR>			
CN001	1-506-478-11	PIN, CONNECTOR 13P	
<DIODE>			
D001	8-719-920-05	DIODE SLP281C-50	
D002	8-719-109-68	DIODE D03.685B1	
<RESISTOR>			
R001	1-247-713-11	CARBON 1K 5%	1/4W
R002	1-216-295-00	METAL GLAZE 0	5% 1/10W

REF. NO.	PART NO.	DESCRIPTION	REMARK
<VARIABLE RESISTOR>			
RV001	1-241-846-11	RES. VAR. CARBON 20K	
RV002	1-241-846-11	RES. VAR. CARBON 20K	
RV003	1-241-845-11	RES. VAR. CARBON 20K	
RV004	1-241-845-11	RES. VAR. CARBON 20K	
RV005	1-241-845-11	RES. VAR. CARBON 20K	
<SWITCH>			
S001	1-554-419-00	SWITCH, PUSH (1 KEY)	
S003	1-554-419-00	SWITCH, PUSH (1 KEY)	
S004	1-554-419-00	SWITCH, PUSH (1 KEY)	
S005	1-554-419-00	SWITCH, PUSH (1 KEY)	

#A-1390-277-C	S BOARD, COMPLETE	*****	
#3-738-015-01	COVER, (DIA. 6) CARBON VR		
<CAPACITOR>			
C1101	1-163-119-00	CERAMIC CHIP 120PF	5% 50V
C1102	1-164-004-11	CERAMIC CHIP 0.1MF	10% 25V
C1103	1-124-589-11	ELECT 47MF	20% 16V
C1104	1-163-031-11	CERAMIC CHIP 0.01MF	5% 50V
C1105	1-163-114-00	CERAMIC CHIP 75PF	5% 50V
C1106	1-163-101-00	CERAMIC CHIP 22PF	5% 50V
C1107	1-164-004-11	CERAMIC CHIP 0.1MF	10% 25V
C1108	1-163-119-00	CERAMIC CHIP 120PF	5% 50V
C1109	1-163-031-11	CERAMIC CHIP 0.01MF	5% 50V
C1110	1-163-117-00	CERAMIC CHIP 100PF	5% 50V
C1111	1-163-018-00	CERAMIC CHIP 0.0056MF	10% 50V
C1112	1-126-160-11	ELECT 1MF	20% 50V
C1113	1-163-119-00	CERAMIC CHIP 120PF	5% 50V
C1114	1-163-103-00	CERAMIC CHIP 27PF	5% 50V
C1115	1-164-004-11	CERAMIC CHIP 0.1MF	10% 25V
C1116	1-163-114-00	CERAMIC CHIP 75PF	5% 50V
C1117	1-124-589-11	ELECT 47MF	20% 16V
C1118	1-164-004-11	CERAMIC CHIP 0.1MF	10% 25V
C1119	1-163-020-00	CERAMIC CHIP 0.0082MF	10% 50V
C1120	1-163-097-00	CERAMIC CHIP 15PF	5% 50V
C1121	1-163-097-00	CERAMIC CHIP 15PF	5% 50V
C1122	1-163-222-11	CERAMIC CHIP 5PF	0.25PF 50V
C1123	1-163-097-00	CERAMIC CHIP 15PF	5% 50V
C1130	1-163-097-00	CERAMIC CHIP 15PF	5% 50V
C1131	1-163-097-00	CERAMIC CHIP 15PF	5% 50V
<CONNECTOR>			
CN1101	#1-565-488-11	CONNECTOR, BOARD TO BOARD 12P	
<DIODE>			
D1101	8-719-404-46	DIODE MA110	
D1102	8-719-404-46	DIODE MA110	
<IC>			
IC1101	8-752-056-67	IC CXA1214P	
<COIL>			

S

G

ingents identified by
nd mark Δ are criti-
cally.

only with part number

Les composants identifiés par
une trame et une marque Δ
sont critiques pour la sécurité.
Ne les remplacer que par une
pièce portant le numéro spécifié.

RT NO.	DESCRIPTION	REMARK	REF. NO.	PART NO.	DESCRIPTION	REMARK
408-411-00	INDUCTOR 150H					
404-496-00	COIL					
404-496-00	COIL					
408-411-00	INDUCTOR 150H					
412-008-31	INDUCTOR CHIP 150H					
412-008-31	INDUCTOR CHIP 150H					

G BOARD (SOPS-1021)						

4-312-134-11 RIVET NYLON 5.5P						
<CAPACITOR>						
C601	Δ 1-136-889-11	METALIZED FILM 0.22MF	20%	250V		
C602	Δ 1-136-889-11	METALIZED FILM 0.22MF	20%	250V		
C603	Δ 1-161-973-51	CERAMIC 220PF	10%	400V		
C604	Δ 1-161-973-51	CERAMIC 220PF	10%	400V		
C605	Δ 1-161-973-51	CERAMIC 220PF	10%	400V		
C608	Δ 1-161-742-51	CERAMIC 0.0022MF	20%	400V		
C609	Δ 1-161-742-51	CERAMIC 0.0022MF	20%	400V		
C610	Δ 1-125-724-11	ELECT 180MF	20%	400V		
C611	Δ 1-136-206-21	METALIZED FILM 0.033MF	10%	630V		
C612	Δ 1-124-910-51	ELECT 47MF	20%	50V		
C613	Δ 1-137-190-91	METALIZED FILM 0.22MF	5%	50V		
C614	Δ 1-137-190-91	METALIZED FILM 0.22MF	5%	50V		
C615	Δ 1-130-971-91	PE TEREPHTHALATE 0.001MF	5%	50V		
C651	Δ 1-161-925-11	CERAMIC 100PF B	10%	500V		
C652	Δ 1-128-486-51	ELECT 680MF	20%	50V		
C653	Δ 1-128-485-51	ELECT 220MF	20%	50V		
C654	Δ 1-130-483-91	PE TEREPHTHALATE 0.01MF	5%	50V		
<CONNECTOR>						
EN610	Δ 1-560-436-11	HORIZONTAL PIN ASSY 3P				
EN651	Δ 1-564-518-11	PLUG CONNECTOR 3P				
<DIODE>						
D201	Δ 8-719-971-08	DIODE ESAC39M 060				
D601	Δ 8-719-510-27	DIODE D35B60				
D602	Δ 8-719-921-20	DIODE 1SS119TD				
D603	Δ 8-719-981-47	DIODE 6RA38-06TP1				
D604	Δ 8-719-981-47	DIODE 6RA38-06TP1				
D605	Δ 8-719-113-44	DIODE RD20ES-T1B3				
D651	Δ 8-719-971-08	DIODE ESAC39M 060				
<IC>						
IC601	Δ 8-809-086-12	IC CN 1018				
IC651	Δ 8-759-908-15	IC TL431CLP				
IP601	Δ 8-759-045-81	IC TL732GR-LK2				
<COIL>						
L601	Δ 1-424-616-11	TRANSFORMER LINE FILTER				
L602	Δ 1-424-574-11	L.F.F				
L651	Δ 1-424-255-41	COIL CHOKE (ENGLDE) 100H				
L652	Δ 1-424-615-11	COIL CHOKE				
<TRANSISTOR>						
Q601	Δ 1-729-322-11	TRANSISTOR 2N1402A				
<RESISTOR>						
1-238-015-11	RES. ADJ. ρ		1.5	5%	5W	F
1-238-013-11	RES. ρ		1.5	5%	5W	F
			100K	5%	2W	F
			100K	5%	2W	F

- The components identified by \boxtimes in this manual have been carefully factory-selected for each set in order to satisfy regulations regarding X-ray radiation. Should replacement be required, replace only with the value originally used.

Les composants identifiés par une trame et une marque \boxtimes sont critiques pour la sécurité. Ne les remplacer que par une pièce portant le numéro spécifique.

The components identified by shading and mark \boxtimes are critical for safety. Replace only with part number specified.

RT NO.	DESCRIPTION	REMARK
212-865-61	FUSIBLE 22 5% 1/4W F	
247-805-91	CARBON 82 5% 1/4W	
260-124-91	CARBON 270K 5% 1/2W	
260-128-91	CARBON 270K 5% 1/2W	
215-904-51	METAL OXIDE 100K 5% 2W F	
207-455-11	WIRE 0.22 10% 1/2W	
247-789-91	CARBON 18 5% 1/4W	
247-795-91	CARBON 33 5% 1/4W	
215-904-51	METAL OXIDE 100K 5% 2W F	
247-815-91	CARBON 220 5% 1/4W	
215-886-51	METAL OXIDE 100 5% 2W F	
215-886-51	METAL OXIDE 100 5% 2W F	
260-107-91	CARBON 4.7K 5% 1/2W	
260-107-91	CARBON 4.7K 5% 1/2W	
247-867-91	CARBON 33K 5% 1/4W	
247-867-91	CARBON 33K 5% 1/4W	
247-837-91	CARBON 1.8K 5% 1/4W	

<VARIABLE RESISTOR>

~~237-483-11 RES. ADJ. CARBON 1K~~

<TRANSFORMER>

~~150-300-12 TRANSFORMER CONVERTED~~

MISCELLANEOUS

413-720-21 SWITCHING REGULATOR (SOPS-1021)

426-614-11 COIL, DEMAGNETIZATION

451-325-11 DEFLECTION YOKE (X06JVA2)

452-126-11 MAGNET

543-925-11 CORE, FERRITE

544-252-11 SPEAKER

576-232-11 FUSE (H.F.C.3) (5A/250V)

923-183-01 WIRE UL1007 AWG18 50MM BLK

733-921-05 CRT 06TV

ACCESSORIES & PACKING MATERIALS

RT NO.	DESCRIPTION	REMARK
590-910-11	CORD SET, POWER (10A/250V)	
590-871-11	CABLE (MINI DIN) 8P	
990-241-02	HOLDER (A), PLUG	
170-078-01	HOLDER (B), PLUG	
755-607-11	MANUAL, INSTRUCTION	
336-595-01	INDIVIDUAL CARTON	
336-599-01	CUSHION (LOWER) (ASSY)	
336-600-01	CUSHION (UPPER) (ASSY)	

PVM-6041QM



SONY
SERVICE MANUALAEP Model
Chassis No. SCC-F09D-A

CORRECTION-2

Correct the service manual as shown below.
File this collection with the service manual. : Corrected portion

SECTION 7 EXPLODED VIEWS

7-1. CHASSIS (See page 76)

Incorrect	Correct				
<p>■ : +P4 × 25 7-685-567-09</p>	<p>■ : +P4 × 25 7-682-567-09</p> <p></p>				
<p>—</p>	<table border="1"> <thead> <tr> <th>PART. NO.</th> <th>DESCRIPTION</th> </tr> </thead> <tbody> <tr> <td>1-941-906-07</td> <td>CONNECTOR ASSY, VH 3P (DC12V IN Jack)</td> </tr> </tbody> </table> <p></p>	PART. NO.	DESCRIPTION	1-941-906-07	CONNECTOR ASSY, VH 3P (DC12V IN Jack)
PART. NO.	DESCRIPTION				
1-941-906-07	CONNECTOR ASSY, VH 3P (DC12V IN Jack)				

SECTION 8 ELECTRICAL PARTS LIST (See page 88)

D BOARD

Incorrect		Correct	
PART. NO.	DESCRIPTION	PART. NO.	DESCRIPTION
* A-1341-562-A	D BOARD, COMPLETE	* A-1346-067-A	D BOARD, COMPLETE
			



1930

1930

1930

1930

1930

1930

1930

1930

1930

1930

1930

1930

1930

1930

PVM-6041QM

SP0186

SONY SERVICE MANUAL

AEP Model
Chassis No. SCC-F09D-A

SUPPLEMENT-1

INTRODUCTION

- B board : The transistor is changed to the pair transistor (Q189).
The diodes are changed to the three-terminal diodes (D185, D186, D187, D188, D191, D390 and D1392).
- D board : The transistors are changed to the pair transistors (Q569, Q576, Q579 and Q599).
The diodes are changed to the three-terminal diodes (D520, D521, D589, D648, D1620, D1622 and D1623).
- S board : The pattern is modified.

Note)

Before using the circuit board, confirm that the parts number shown below and the parts number of the circuit board which is being used in your set are the same.

Board (Complete No.)	Board Part. No.
B (A-1135-726-A)	1-641-716-15
D (A-1346-067-A)	1-641-717-16
S (A-1394-392-A)	1-641-719-15



TABLE OF CONTENTS

<u>Section</u>	<u>Title</u>	<u>Page</u>
1. DIAGRAMS		
1-1.	Circuit Boards Location	3
1-2.	Printed Wiring Boards and Schematic Diagrams	3
	S Board	4
	D Board	7
	B Board	16
2. ELECTRICAL PARTS LIST	31

(CAUTION)

SHORT CIRCUIT THE ANODE OF THE PICTURE TUBE AND THE ANODE CAP TO THE METAL CHASSIS, CRT SHIELD, OR CARBON PAINTED ON THE CRT, AFTER REMOVING THE ANODE.

WARNING!!

AN ISOLATION TRANSFORMER SHOULD BE USED DURING ANY SERVICE TO AVOID POSSIBLE SHOCK HAZARD, BECAUSE OF LIVE CHASSIS.

THE CHASSIS OF THIS RECEIVER IS DIRECTLY CONNECTED TO THE AC POWER LINE.

SAFETY-RELATED COMPONENT WARNING !!

COMPONENTS IDENTIFIED BY SHADING AND MARK Δ ON THE SCHEMATIC DIAGRAMS, EXPLODED VIEWS AND IN THE PARTS LIST ARE CRITICAL TO SAFE OPERATION. REPLACE THESE COMPONENTS WITH SONY PARTS WHOSE PART NUMBERS APPEAR AS SHOWN IN THIS MANUAL OR IN SUPPLEMENTS PUBLISHED BY SONY. CIRCUIT ADJUSTMENTS THAT ARE CRITICAL TO SAFE OPERATION ARE IDENTIFIED IN THIS MANUAL. FOLLOW THESE PROCEDURES WHENEVER CRITICAL COMPONENTS ARE REPLACED OR IMPROPER OPERATION IS SUSPECTED.

SECTION 1
DIAGRAMS

1-1. CIRCUITS BOARDS LOCATION

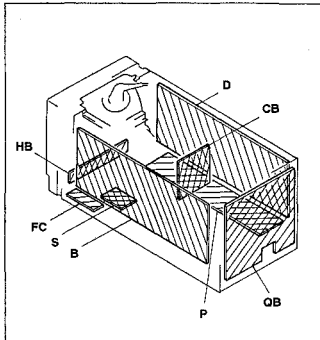

Part replaced (■)	Adjustment (⊠)
IC801, IC851, PH802, C855, R853, R855, R856, R857, RV851	RV651 (B+ MAX)
Q1801, Q1802, Q1803, D1801, D1803, D1822, C1801, C1802, R1801, R1802, R1803, R1804, R1806, R1808, R1807, R1808, R1823, R1829, R1830, RV1801, RV1803	RV1803 (B+ MAX IN DC POWER INPUT MODE)
IC502, G833, G834, Q835, Q836, D835, D836, C519, C843, C844, C845, C848, C847, C848, RV833, R823, R850, R851, R852, R853, R854, R855, R856, R857, R858, R859, R861, R862, R863, NL801	RS33 (HOLD-DOWN)

- All voltages are in V.
- Voltage are dc with respect to ground unless otherwise noted.
- Readings are taken with a color-bar signal input.
- Readings are taken with a PAL color-bar signal input.
- □ : adjustment for repair.
- Voltage variations may be noted due to normal production tolerances.
- ——— : B + bus.
- - - - - : B - bus.
- <---> : signal path.
- No mark: with PAL color-bar signal received or common voltage.
- () : with SECAM color-bar signal received.
- < > : with NTSC 3.58 color-bar signal received.
- () : with NTSC 4.43 color-bar signal received.
- [] : with S(Y/C) color-bar signal received.
- { } : with analog RGB color-bar signal received.
- << >> : with component color-bar signal received.
- * : measurement impossibility.

Reference information

RESISTOR	RN	METAL FILM
	RC	SOLID
	FFRD	NONFLAMMABLE CARBON
	FUSE	NONFLAMMABLE FUSIBLE
	RS	NONFLAMMABLE WIREWOUND
	RB	NONFLAMMABLE CEMENT
COIL	LF-8L	MICRO INDUCTOR
CAPACITOR	TA	TANTALUM
	PS	STYROL
	PP	POLYPROPYLENE
	PT	MYLAR
	MPS	METALIZED POLYESTER
	MPP	METALIZED POLYPROPYLENE
	ALB	BIPOLAR
	ALT	HIGH TEMPERATURE
	ALR	HIGH RIPPLE

1-2. PRINTED WIRING BOARDS AND SCHEMATIC DIAGRAMS

Note:

- All capacitors are in μ F unless otherwise noted. pF: pF
- 50 WV or less are not indicated except for electrolytic.
- Indication of resistance, which does not have one for rating electrical power, is as follows.

Pitch: 5 mm
Rating electrical power $\frac{1}{4}$ W

- All resistors are in ohms.
- □ : nonflammable resistor.
- □ : fusible resistor.
- Δ : internal component.
- □ : panel designation.
- All variable and adjustable resistors have characteristic curve B, unless otherwise noted.
- The components identified by ⊠ in this basic schematic diagram have been carefully factory-selected for each set in order to satisfy regulations regarding X-ray radiation.
- Should replacement be required, replace only with the value originally used.
- When replacing components identified by ■, make the necessary adjustments indicated. If results do not meet the specified value, change the component identified by ⊠ and repeat the adjustment until the specified value is achieved. (Refer to RV651, RV1803 and RV833 adjust on page 18 and 19.)
- When replacing the part in below table be sure to perform the related adjustment.

S

[SECAM DEMODULATION]

- S Board - -- Component Side -

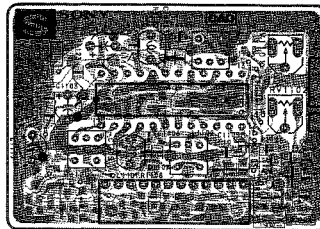

- □ : Pattern from the side which enables seeing.
- □ : Pattern of the rear side.

- S Board - -- Conductor Side -

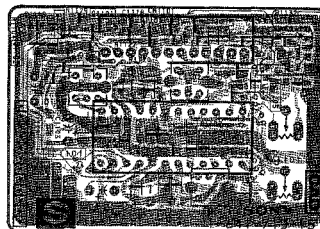

- □ : Pattern from the side which enables seeing.
- □ : Pattern of the rear side.

A
B
C
D
E
F
G
H
I
J

S Board IC1101 CXA1214P

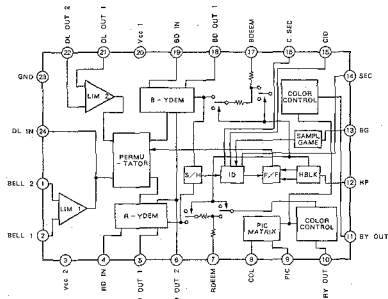
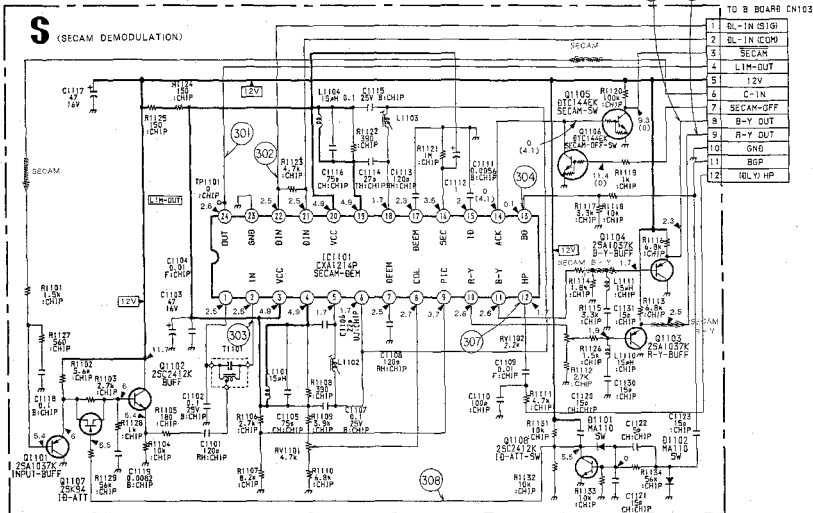

• S BOARD WAVEFORMS

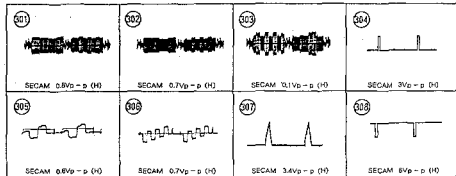

• D BOARD WAVEFORMS

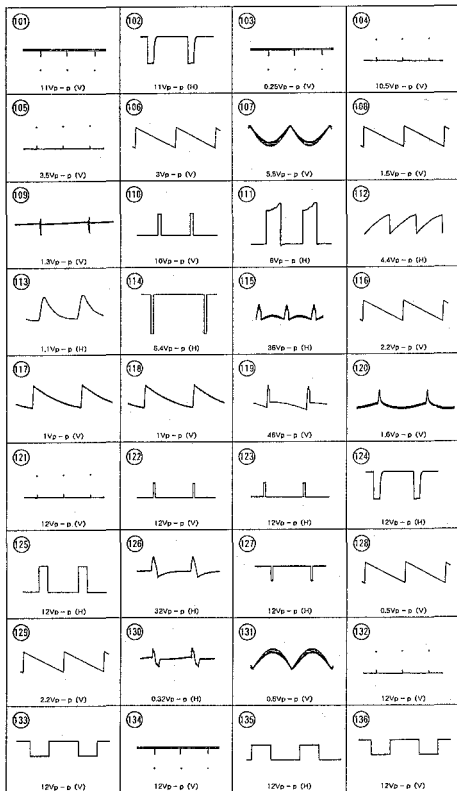

CH1	1
W.FREQ	1
TIME	0.1

112V	2
500K	10
V.P	5
V.BLK	5
H.BLK	2
50K	1
50K	1
POWER LED	2
10.0V	2
+12V	1

TO D BOARD (CH1)

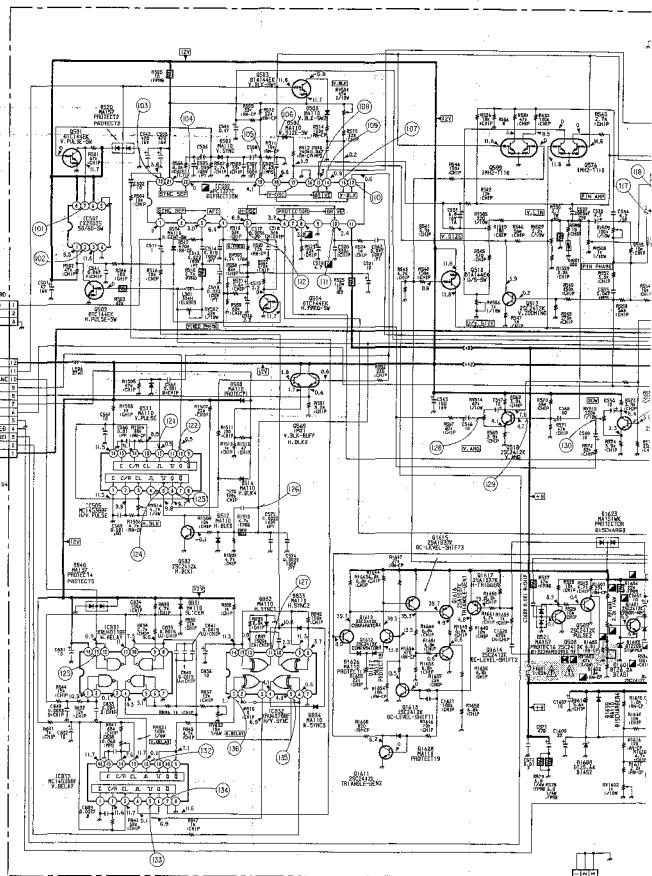

DESIGN
SHEET NO
15 001 REAR CHASSIS

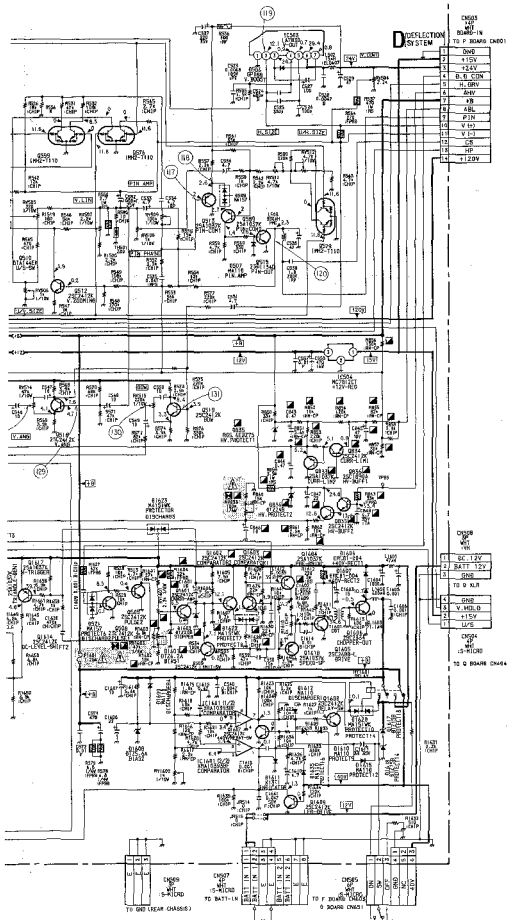

D BOARD IC501 CX23025

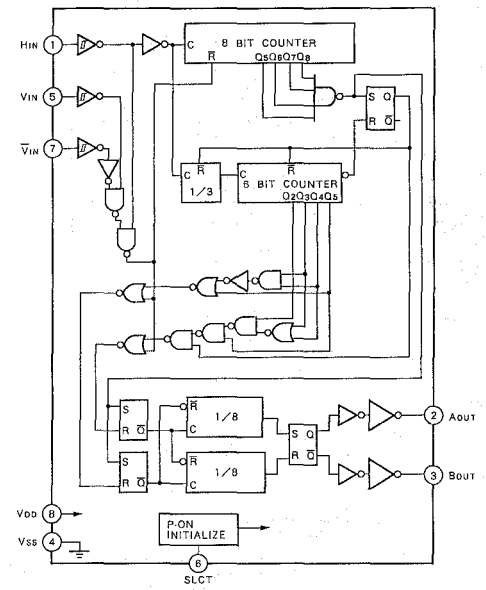

D BOARD IC503 LA7830

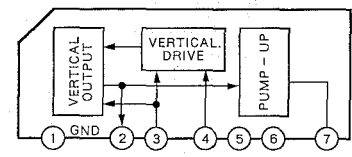

A
B
C
D
E
F
G
H
I
J

D

(DEFLECTION SYSTEM)

- D Board - Component Side -

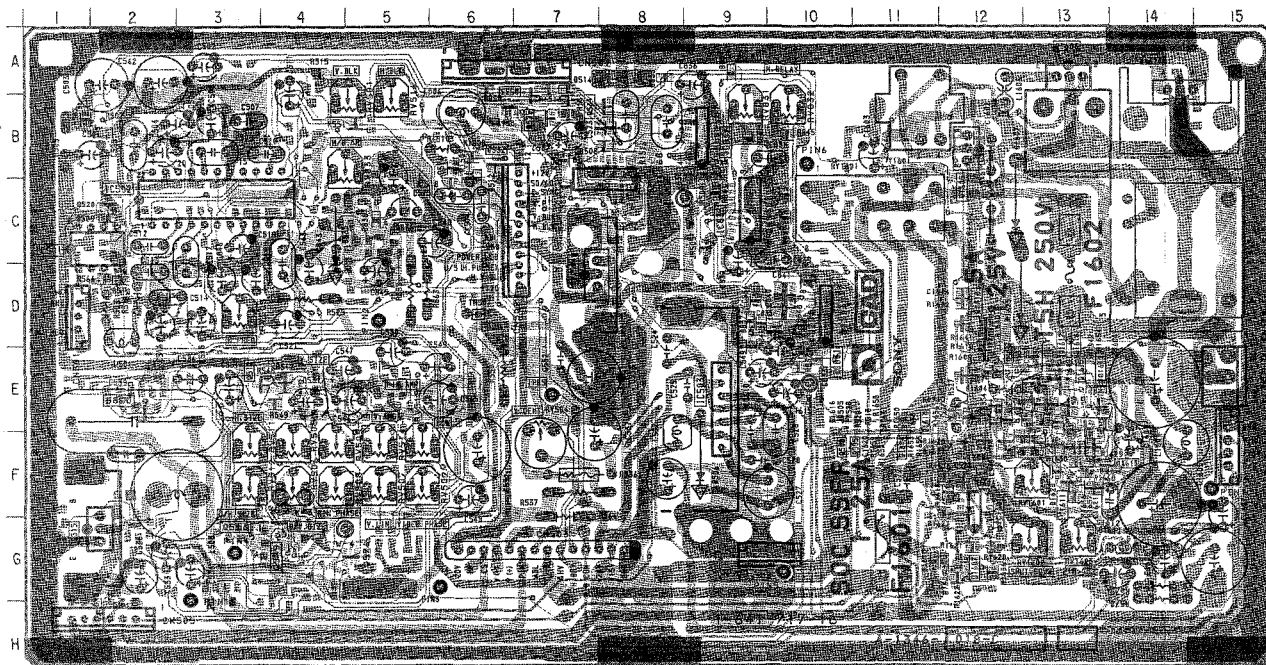

D Board (Component Side)

IC	
IC505	C-8
IC811	D-10
IC822	B-9
IC833	C-9
IC1801	F-12
TRANSISTOR	
Q505	F-12
Q509	F-12
Q509	E-12
Q512	E-4
Q522	B-6
Q576	C-5
Q579	G-4
Q589	E-2
Q1607	G-12
Q1810	E-13
Q1811	F-13
Q1812	E-13
Q1813	F-13
Q1814	F-13
Q1815	E-13
Q1816	E-13
Q1817	E-13
Q1818	D-12
DIODE	
D508	A-5
D512	C-9
D514	A-7
D520	C-2
D521	F-12
D533	A-8
D534	A-8
D638	C-5
D645	D-10
D1608	G-12
D1810	G-10
D1826	F-13
D1827	F-13
D1828	F-13

- : Pattern from the side which enables seeing.
- : Pattern of the rear side.

- D Board - - Conductor Side -

D Board (Component Side)

IC	
K505	C-8
K231	D-10
K232	B-9
K233	C-9
K1601	F-12
TRANSISTOR	
Q505	F-12
Q508	F-12
Q509	E-12
Q512	E-4
Q532	B-6
Q576	G-5
Q578	G-4
Q589	E-2
Q1607	G-12
Q1610	E-13
Q1611	F-13
Q1612	E-13
Q1613	F-13
Q1614	F-13
Q1615	E-13
Q1616	E-13
Q1617	E-13
Q1618	D-12
DIODE	
D608	A-8
D512	C-8
D514	A-7
D620	C-2
D621	F-12
D633	A-8
D634	A-9
D636	C-5
D646	D-10
D1809	G-12
D1810	G-10
D1826	F-13
D1627	F-13
D1628	F-13

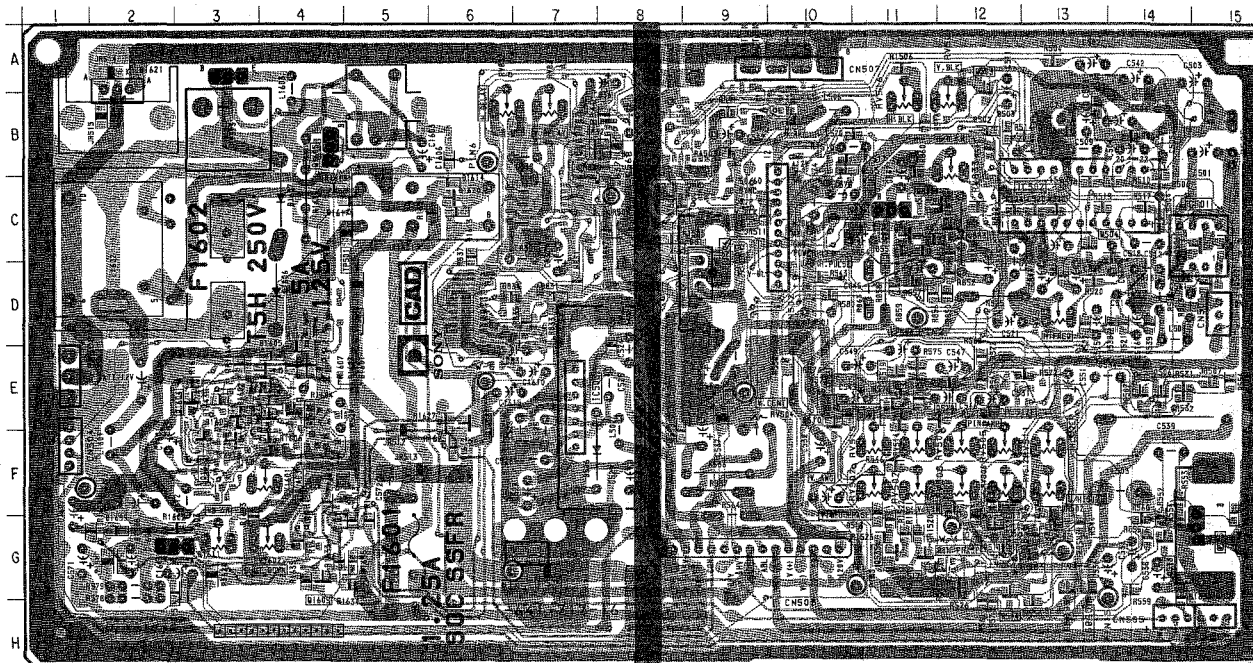

- : Pattern from the side which enables seeing.
- : Pattern of the rear side.

ctor Side -

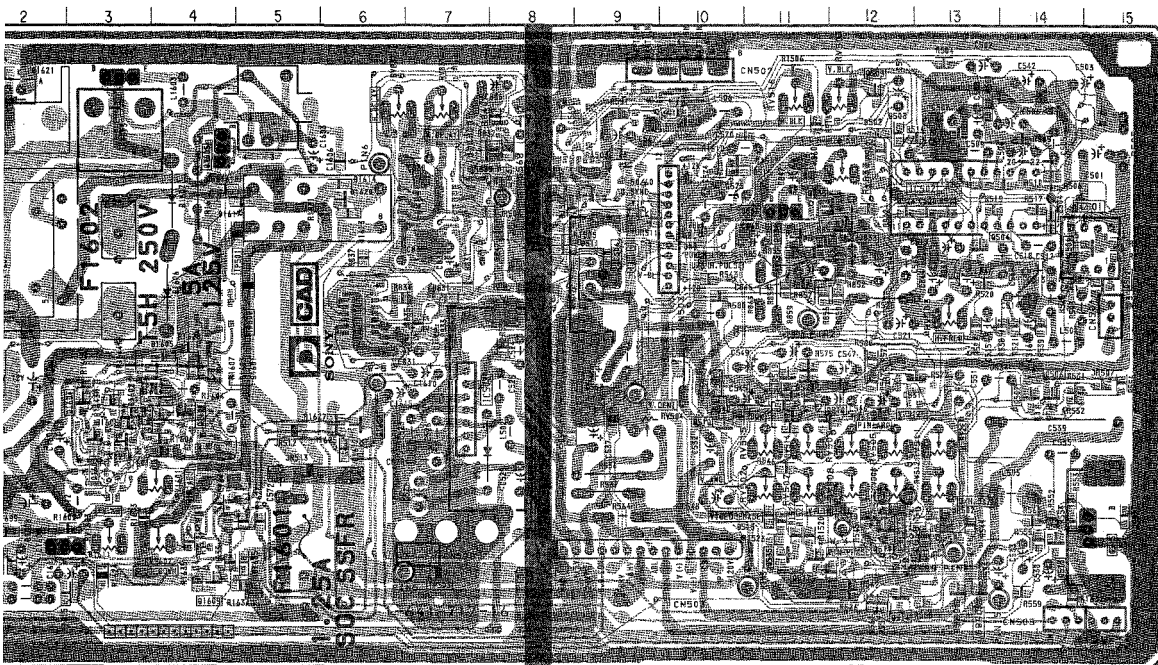

D Board (Conductor Side)

IC	D835	C-12	
IC301	C-15	D1601	E-4
IC302	C-13	D1603	E-4
IC303	E-7	D1606	D-4
IC304	D-9	D1607	C-4
		D1608	G-2
		D1611	Q-3
		D1612	F-6
		D1615	G-2
		D1617	C-4
		D1618	C-4
		D1620	C-6
		D1622	E-4
		D1623	F-3
		D1635	G-5
		D1889	G-2
TRANSISTOR	VARIABLE RESISTOR		
Q301	C-15	RV501	B-12
Q302	D-15	RV502	F-11
Q303	A-12	RV503	D-13
Q304	C-18	RV504	E-9
Q310	E-10	RV505	F-12
Q313	G-14	RV506	F-12
Q315	G-15	RV507	F-11
Q318	F-12	RV508	F-12
Q319	E-11	RV509	F-12
Q588	B-6	RV510	F-13
Q589	G-13	RV511	F-13
Q832	C-12	RV512	F-13
Q834	C-11	RV514	F-11
Q835	C-11	RV515	F-11
Q836	C-11	RV516	B-11
Q1801	E-4	RV531	B-7
Q1802	E-4	RV532	B-6
Q1803	F-3	RV533	B-12
Q1804	E-3	RV1601	F-4
Q1805	B-4	RV1602	G-4
Q1806	A-3	RV1603	G-3
Q1808	E-6		
Q1809	G-4		
DIODE			
D501	B-13		
D502	B-12		
D503	B-12		
D504	G-14		
D506	F-7		
D507	G-15		
D511	C-9		
D585	G-13		
D831	D-7		
D832	B-7		

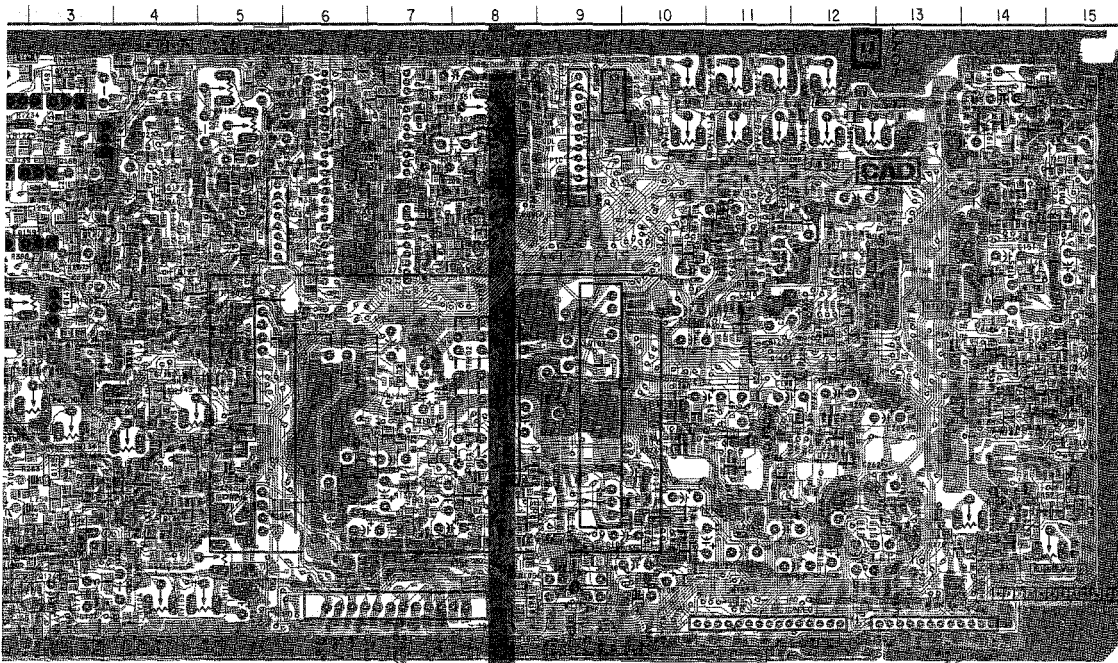

- : Pattern from the side which enables seeing.
- : Pattern of the rear side.

Side --



B Board (Conductor Side)

IC			IC		IC		IC		VARIABLE RESISTOR
IC102	G-3	Q174	C-4	RV101	G-15				
IC124	C-7	Q175	C-4	RV102	G-14				
		Q177	A-4	RV103	E-4				
		Q178	A-4	RV104	F-4				
		Q190	C-12	RV105	H-5				
		Q192	B-14	RV106	H-4				
		Q194	B-15	RV107	G-5				
		Q195	B-14	RV108	D-2				
		Q198	A-15	RV109	F-1				
		Q201	C-7	RV110	E-1				
		Q202	C-8	RV111	D-2				
		Q203	C-8	RV112	E-2				
		Q210	B-2	RV113	F-3				
		Q211	C-2	RV114	E-3				
		Q217	F-15	RV115	A-10				
		Q218	E-4	RV116	B-11				
		Q219	F-15	RV117	B-12				
		Q220	F-4	RV118	A-12				
		Q222	F-4	RV119	A-11				
		Q223	F-5	RV120	A-11				
		Q225	H-2	RV121	A-11				
		Q226	H-2	RV122	A-10				
		Q227	H-4	RV123	B-8				
		Q228	H-3	RV124	B-5				
		Q229	H-3	RV125	A-5				
		Q230	G-4	RV205	B-11				
		Q231	C-2						
		Q232	F-12						
		Q233	G-3						
		Q234	F-3						
		Q235	F-3						
		Q236	F-12						
		Q237	F-12						
		Q238	F-12						
		Q239	H-2						
		Q240	E-11						
		Q241	C-10						
		Q242	C-10						
		Q243	C-11						
		Q244	A-7						
		Q245	C-7						
		Q246	B-3						
		Q247	D-3						
		Q248	A-2						
		Q249	B-2						
		Q250	B-2						
		Q251	B-2						
		Q252	B-2						
		Q253	C-7						
		Q254	C-2						
		Q255	C-2						
		Q256	B-3						
		Q257	B-3						
		Q258	B-3						
		Q259	C-3						
		Q260	A-4						
		Q261	C-3						
		Q262	D-4						
		Q263	C-5						
		Q264	C-5						
		Q265	C-4						
		Q266	C-4						
		Q267	D-4						

-  : Pattern from the side which enables seeing.
-  : Pattern of the rear side.

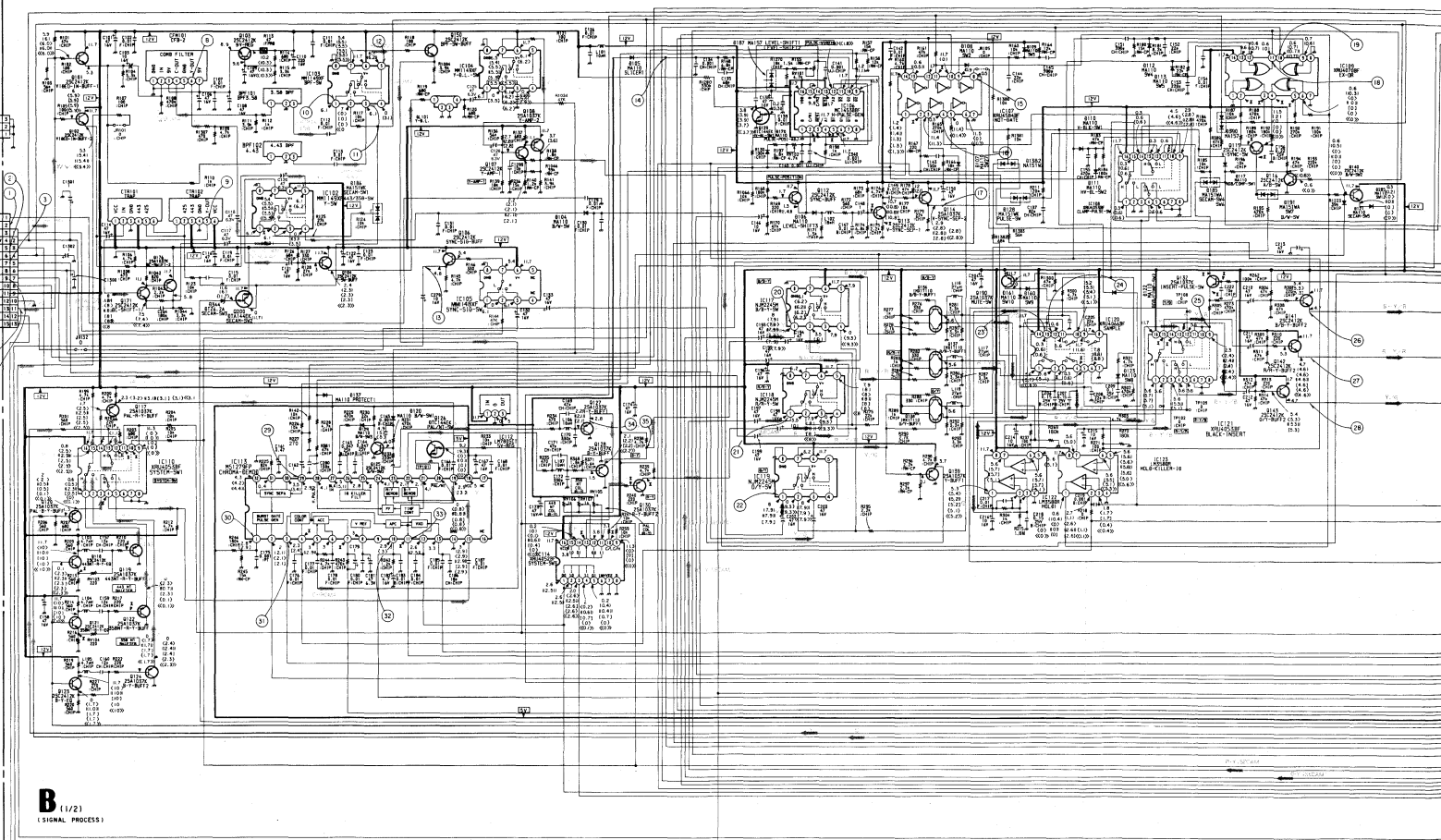

A
B
C
D
E
F
G
H
I
J

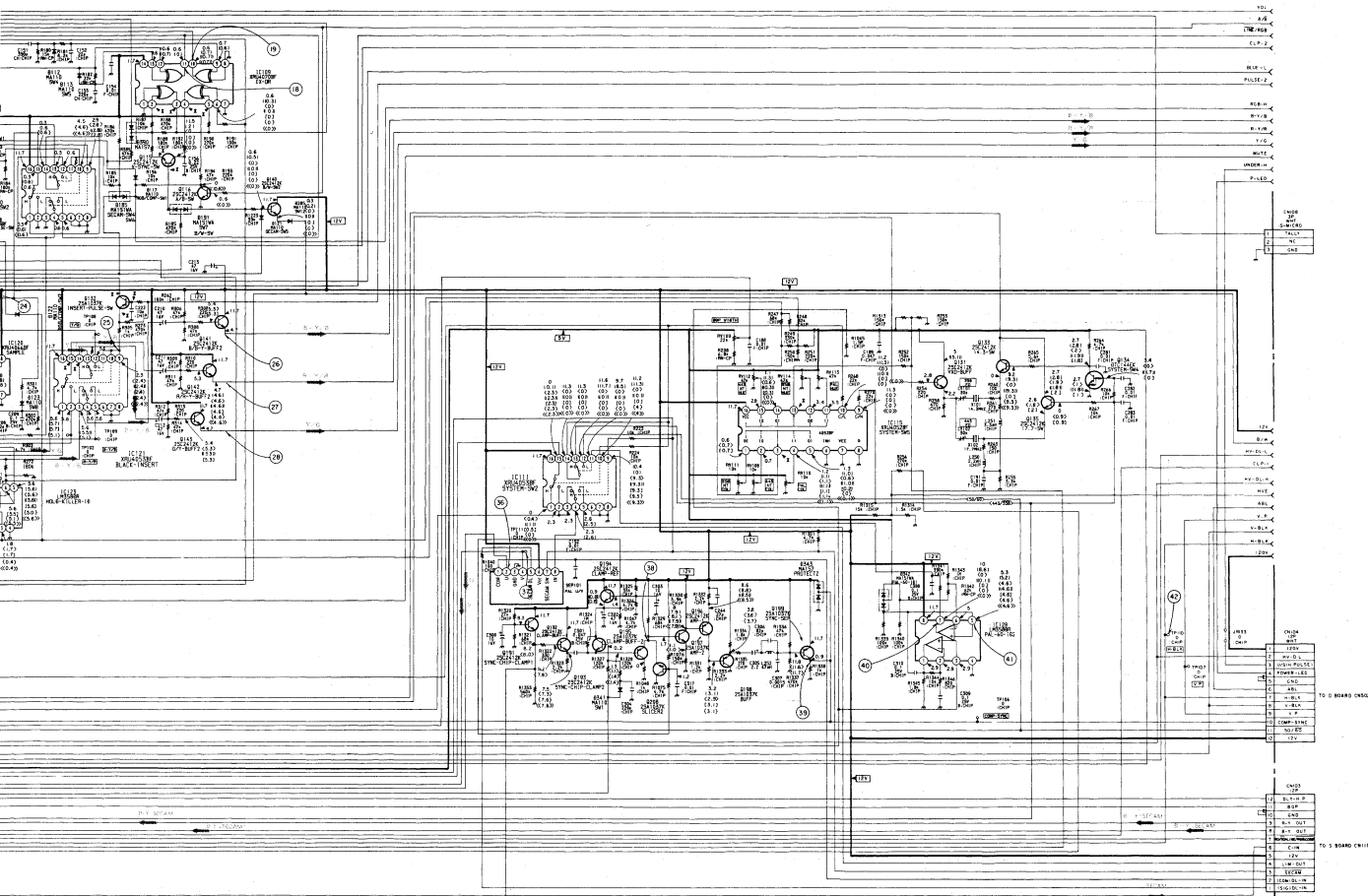

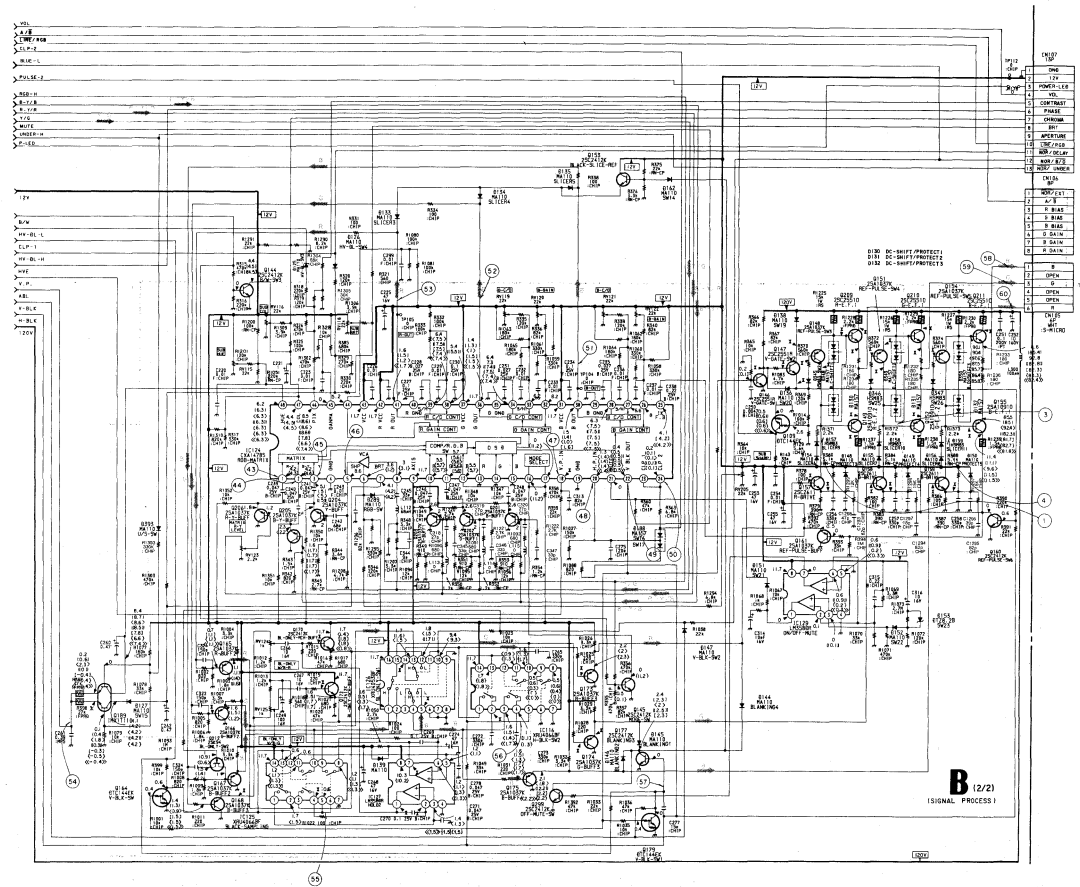

1	RES
2	RES
3	POWER_16
4	RES
5	RES
6	RES
7	RES
8	RES
9	RES
10	RES
11	RES
12	RES
13	RES
14	RES
15	RES
16	RES
17	RES
18	RES
19	RES
20	RES
21	RES
22	RES
23	RES
24	RES
25	RES
26	RES
27	RES
28	RES
29	RES
30	RES
31	RES
32	RES
33	RES
34	RES
35	RES
36	RES
37	RES
38	RES
39	RES
40	RES
41	RES
42	RES
43	RES
44	RES
45	RES
46	RES
47	RES
48	RES
49	RES
50	RES
51	RES
52	RES
53	RES
54	RES
55	RES
56	RES
57	RES
58	RES
59	RES
60	RES
61	RES
62	RES
63	RES
64	RES
65	RES
66	RES
67	RES
68	RES
69	RES
70	RES
71	RES
72	RES
73	RES
74	RES
75	RES
76	RES
77	RES
78	RES
79	RES
80	RES
81	RES
82	RES
83	RES
84	RES
85	RES
86	RES
87	RES
88	RES
89	RES
90	RES
91	RES
92	RES
93	RES
94	RES
95	RES
96	RES
97	RES
98	RES
99	RES
100	RES

— B
X

Q113	
Q115	
Q118	
Q119	
Q121	
Q122	
Q120	
Q132	
D147	
Q148	
Q149	
Q151	
Q152	
Q154	
Q155	
Q157	
Q158	
Q159	
Q163	
Q168	
Q168	
Q170	
Q172	
Q173	
Q174	
Q178	
Q209	
Q210	
Q211	

- B Board -

< TRANSISTOR >

		PAL	SECAM	NTSC 3.58	NTSC 4.43	S (V/C)	ANALOG RGB	COMPONENT
Q113	E	0.5	0.5	0.4	0.4	0.5	0.5	0.5
B	1.6	1.6	0.6	0.6	0.6	0.6	0.6	0.6
Q115	E	11.2	8.3	10	10.8	6.0	6.0	6.0
B	2.8	2.2	6.1	2.4	0.1	0.1	0.0	
Q118	E	0.0	0.0	1.7	1.7	1.7	1.7	1.7
B	0.1	0.0	1.7	1.7	1.7	1.7	1.7	
Q121	E	0.0	0.0	1.7	1.7	1.7	1.7	1.7
B	0.0	0.0	1.7	1.7	1.7	1.7	1.7	
Q130	E	4.3	4.3	4.4	4.4	4.5	4.4	4.4
B	3.7	3.7	3.8	3.8	3.8	3.8	3.8	
Q132	E	2.3	2.3	2.4	2.3	2.4	2.4	2.4
B	1.8	1.7	1.7	1.7	1.7	1.8	1.8	
B	2.7	2.8	2.8	2.7	2.8	2.7	2.8	
Q144	C	116.7	114.4	110.4	112.2	113.7	114.3	114.1
Q147	E	117.9	115.6	111.8	114.5	115.0	115.5	115.4
C	126.0	123.5	120.3	123.4	123.8	124.8	124.4	
B	116.8	116.5	110.5	116.4	116.2	114.2	114.2	
Q149	C	86.1	84.9	91.2	83.4	82.8	82.5	82.2
B	84.0	93.3	86.9	82.4	82.1	84.2	86.8	
Q149	E	1.8	1.8	1.4	1.7	1.7	1.7	1.7
B	82.1	82.7	100.2	89.5	82.4	80.5	88.9	
Q152	E	86.1	86.0	92.9	80.8	82.9	82.8	82.7
C	104.8	103.5	91.7	104.9	104.9	104.9	110.0	
Q154	B	82.5	82.9	99.8	90.1	88.7	80.4	89.2
Q155	B	88.2	88.5	95.7	85.7	83.9	84.8	83.9
Q157	E	82.4	81.1	87.5	78.0	78.0	80.8	78.4
B	86.0	84.8	91.2	84.4	82.7	82.5	82.1	
Q158	E	1.8	1.5	1.3	1.8	1.8	1.7	1.7
B	2.1	2.0	1.8	2.1	2.2	2.2	2.2	
Q168	E	1.8	1.8	1.3	1.8	1.7	1.7	1.7
B	2.2	2.1	1.5	2.1	2.2	2.2	2.2	
Q183	E	0.2	0.8	2.7	0.5	-0.5	-0.7	-0.8
Q186	0	0.0	0.0	0.0	1.0	1.0	1.0	1.0
Q189	C	2.1	2.0	1.8	2.1	2.2	2.1	2.2
Q170	B	2.3	2.3	2.1	2.4	2.4	2.4	2.4
Q172	B	2.2	2.1	1.9	2.2	2.3	2.2	2.3
Q173	B	1.7	1.8	1.4	1.7	1.7	1.7	1.7
Q174	E	2.1	2.0	1.8	2.1	2.2	2.2	2.2
B	1.8	1.5	1.3	1.8	1.8	1.7	1.7	
Q178	B	6.2	6.3	6.2	6.3	6.1	6.2	6.2
Q209	E	83.4	81.5	87.9	80.3	80.4	80.4	79.8
C	115.8	112.0	110.7	112.2	112.8	114.5	114.2	
B	87.8	86.4	82.8	83.0	84.3	84.2	83.8	
Q210	E	86.5	86.3	93.1	83.0	83.3	83.0	82.8
C	118.5	114.2	111.5	113.9	114.5	115.1	114.9	
Q211	C	115.9	113.8	111.7	115.3	115.8	114.5	114.3

< IC >

		PAL	SECAM	NTSC 3.58	NTSC 4.43	S (V/C)	ANALOG RGB	COMPONENT
IC102	⊕	8.8	8.8	0.0	8.8	0.0	0.0	0.0
IC108	⊕	0.2	0.1	0.1	0.1	0.1	0.1	0.2
⊖	1.8	1.7	1.7	1.7	1.7	1.8	1.8	
IC107	⊕	10.7	10.7	10.6	10.8	10.6	10.6	10.6
⊖	1.2	10.7	0.0	0.0	0.0	0.0	0.0	
IC108	⊕	8.7	0.4	8.7	9.8	9.8	11	9.7
⊖	11.3	11.3	0.0	10.8	0.0	0.0	0.0	
IC109	⊕	11.3	11.4	0.0	11.3	0.0	0.0	0.0
⊖	11.7	0.0	0.0	11.7	0.0	0.0	0.0	
⊖	11.0	11.1	0.0	11.0	0.0	0.0	0.0	
IC110	⊕	2.1	2.2	2.3	2.5	2.5	2.5	2.5
⊖	11.3	11.3	0.0	11.3	0.0	0.0	0.0	
⊖	11.3	11.3	0.0	0.0	0.0	0.0	0.0	
⊖	0.8	0.8	2.5	2.5	2.5	2.5	2.5	
⊖	1.7	1.7	2.5	2.8	2.5	2.5	2.5	
IC113	⊕	2.7	1.1	2.8	2.8	2.8	1.1	1.1
⊖	4.2	4.3	4.2	4.3	4.2	4.8	4.8	
⊖	3.0	2.9	2.8	3.0	2.8	2.8	2.8	
⊖	1.7	1.7	2.5	2.8	2.5	2.5	2.5	
⊖	2.2	2.5	2.8	2.2	1.8	2.8	2.8	
IC114	⊕	11.4	11.3	0.0	0.0	0.0	0.0	0.0
⊖	3.7	3.7	3.6	3.6	3.6	3.9	3.9	
IC115	⊕	1.2	1.1	0.8	0.7	0.7	0.8	0.8
⊖	3.5	3.5	3.4	2.8	3.4	3.4	3.4	
IC116	⊖	0.0	0.0	1.0	1.1	1.1	1.3	1.1
IC120	⊕	5.5	5.6	5.8	5.8	5.8	5.8	5.8
⊖	5.5	5.8	5.8	5.8	5.8	5.8	5.8	
IC121	⊕	5.3	5.3	5.4	5.2	5.2	5.1	5.1
⊖	5.8	5.7	5.8	5.8	5.7	5.7	5.7	
IC122	⊕	5.3	5.3	5.4	5.2	5.2	5.1	5.1
⊖	5.3	5.3	5.4	5.2	5.2	5.1	5.1	
IC124	⊕	0.1	0.1	0.2	0.2	0.2	0.2	0.2
IC125	⊕	1.4	1.4	1.3	1.4	1.5	1.5	1.5
IC126	⊕	1.6	1.5	1.3	1.6	1.6	1.7	1.6
⊖	1.6	1.5	1.3	1.6	1.6	1.6	1.7	
IC127	⊕	1.7	1.8	1.4	1.7	1.7	1.6	1.7
⊖	1.4	1.4	1.3	1.5	1.5	1.5	1.5	
⊖	2.1	2.7	2.4	2.8	2.8	2.8	2.8	

• B BOARD WAVEFORMS

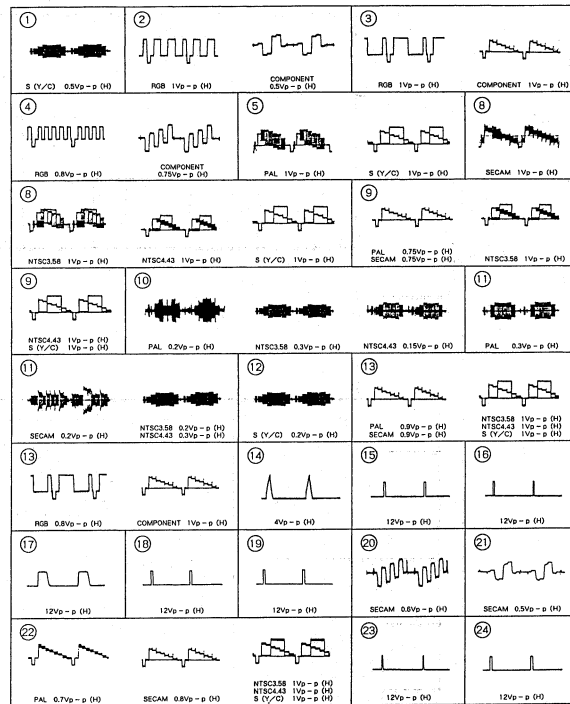

45	1270 - 0 (0)		PAL 1270 - 0 (0)
46	1270 - 0 (0)		SECAM 1270 - 0 (0)
47	1490 - 0 (0)		COMPONENT 1490 - 0 (0)
48	1490 - 0 (0)		SECAM 1490 - 0 (0)
49	1490 - 0 (0)		COMPONENT 1490 - 0 (0)
50	1790 - 0 (0)		SECAM 1790 - 0 (0)
51	1790 - 0 (0)		COMPONENT 1790 - 0 (0)
52	1790 - 0 (0)		SECAM 1790 - 0 (0)
53	1790 - 0 (0)		COMPONENT 1790 - 0 (0)
54	1790 - 0 (0)		SECAM 1790 - 0 (0)
55	1790 - 0 (0)		COMPONENT 1790 - 0 (0)
56	1790 - 0 (0)		SECAM 1790 - 0 (0)
57	1790 - 0 (0)		COMPONENT 1790 - 0 (0)
58	1790 - 0 (0)		SECAM 1790 - 0 (0)
59	1790 - 0 (0)		COMPONENT 1790 - 0 (0)
60	1790 - 0 (0)		SECAM 1790 - 0 (0)
61	1790 - 0 (0)		COMPONENT 1790 - 0 (0)
62	1790 - 0 (0)		SECAM 1790 - 0 (0)
63	1790 - 0 (0)		COMPONENT 1790 - 0 (0)
64	1790 - 0 (0)		SECAM 1790 - 0 (0)
65	1790 - 0 (0)		COMPONENT 1790 - 0 (0)

66	0.2000 - 0 (0)		PAL 0.2000 - 0 (0)
67	0.2000 - 0 (0)		SECAM 0.2000 - 0 (0)
68	0.2000 - 0 (0)		COMPONENT 0.2000 - 0 (0)
69	0.2000 - 0 (0)		SECAM 0.2000 - 0 (0)
70	0.2000 - 0 (0)		COMPONENT 0.2000 - 0 (0)
71	0.2000 - 0 (0)		SECAM 0.2000 - 0 (0)
72	0.2000 - 0 (0)		COMPONENT 0.2000 - 0 (0)
73	0.2000 - 0 (0)		SECAM 0.2000 - 0 (0)
74	0.2000 - 0 (0)		COMPONENT 0.2000 - 0 (0)
75	0.2000 - 0 (0)		SECAM 0.2000 - 0 (0)
76	0.2000 - 0 (0)		COMPONENT 0.2000 - 0 (0)
77	0.2000 - 0 (0)		SECAM 0.2000 - 0 (0)
78	0.2000 - 0 (0)		COMPONENT 0.2000 - 0 (0)
79	0.2000 - 0 (0)		SECAM 0.2000 - 0 (0)
80	0.2000 - 0 (0)		COMPONENT 0.2000 - 0 (0)
81	0.2000 - 0 (0)		SECAM 0.2000 - 0 (0)
82	0.2000 - 0 (0)		COMPONENT 0.2000 - 0 (0)
83	0.2000 - 0 (0)		SECAM 0.2000 - 0 (0)
84	0.2000 - 0 (0)		COMPONENT 0.2000 - 0 (0)
85	0.2000 - 0 (0)		SECAM 0.2000 - 0 (0)
86	0.2000 - 0 (0)		COMPONENT 0.2000 - 0 (0)
87	0.2000 - 0 (0)		SECAM 0.2000 - 0 (0)
88	0.2000 - 0 (0)		COMPONENT 0.2000 - 0 (0)
89	0.2000 - 0 (0)		SECAM 0.2000 - 0 (0)
90	0.2000 - 0 (0)		COMPONENT 0.2000 - 0 (0)
91	0.2000 - 0 (0)		SECAM 0.2000 - 0 (0)
92	0.2000 - 0 (0)		COMPONENT 0.2000 - 0 (0)
93	0.2000 - 0 (0)		SECAM 0.2000 - 0 (0)
94	0.2000 - 0 (0)		COMPONENT 0.2000 - 0 (0)
95	0.2000 - 0 (0)		SECAM 0.2000 - 0 (0)
96	0.2000 - 0 (0)		COMPONENT 0.2000 - 0 (0)
97	0.2000 - 0 (0)		SECAM 0.2000 - 0 (0)
98	0.2000 - 0 (0)		COMPONENT 0.2000 - 0 (0)
99	0.2000 - 0 (0)		SECAM 0.2000 - 0 (0)
100	0.2000 - 0 (0)		COMPONENT 0.2000 - 0 (0)

NOTE: The components identified by a circled number in this manual are not to be replaced unless specifically called for safety. Replace only with part numbers specified.

Les composants identifiés par un numéro en cercle dans ce manuel ne doivent pas être remplacés à moins qu'ils soient expressément appelés en nom dans le manuel. Ne les remplacer que par un numéro de pièce portant le numéro spécifique.

REF. NO. PART NO. DEC 64
#A-1135-726-A 1 B
REPLACES
8FF101 1-26-362-11 FLT
8FF102 1-26-364-11 FLT

C101	1-24-289-11	ELEC
C102	1-26-157-11	ELEC
C103	1-26-157-11	ELEC
C106	1-24-477-11	ELEC
C107	1-65-031-11	GEA
C108	1-24-477-11	ELEC
C109	1-24-477-11	ELEC
C110	1-24-477-11	ELEC
C111	1-65-031-11	GEA
C112	1-65-031-11	GEA
C113	1-65-031-11	GEA
C114	1-65-031-11	GEA
C115	1-65-031-11	GEA
C116	1-24-289-11	ELEC
C117	1-24-289-11	ELEC
C118	1-26-154-11	ELEC
C120	1-26-154-11	ELEC
C121	1-24-477-11	ELEC
C122	1-24-477-11	ELEC
C123	1-65-031-11	GEA
C124	1-65-031-11	GEA
C126	1-26-154-11	ELEC
C128	1-65-031-11	GEA
C129	1-65-031-11	GEA
C130	1-65-031-11	GEA
C132	1-24-289-11	ELEC
C133	1-24-289-11	ELEC
C134	1-65-275-11	ELEC
C135	1-63-112-00	GEA
C138	1-24-289-11	ELEC
C139	1-65-031-11	GEA
C140	1-65-207-00	GEA
C141	1-63-141-00	GEA
C143	1-63-121-00	GEA
C144	1-63-101-00	GEA
C145	1-63-131-00	GEA
C146	1-126-157-11	ELEC

SECTION 2 ELECTRICAL PARTS LIST

B

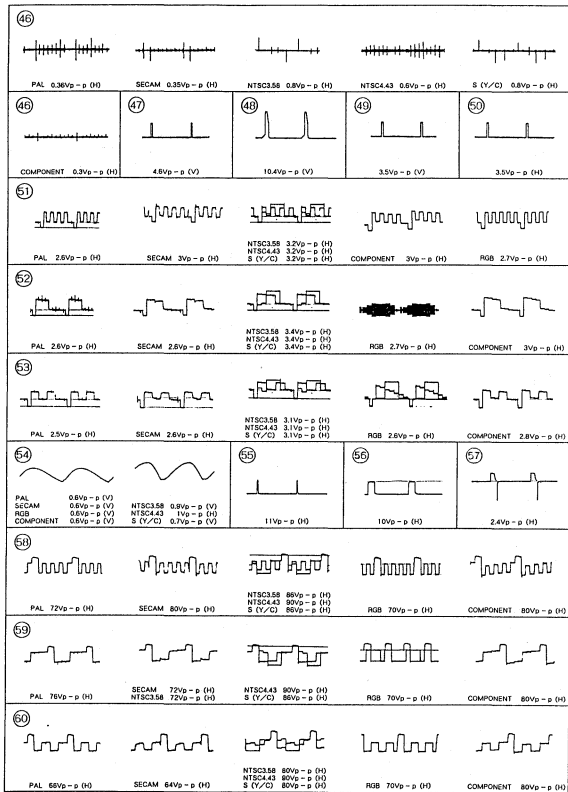

NOTE:

The components identified by shading and mark Δ are critical for safety.
Replace only with part number specified.

Les composants identifiés par une trame et une marque Δ sont critiques pour la sécurité.
Ne les remplacer que par une pièce portant le numéro spécifié.

Items marked " " are not stocked since they are seldom required for routine service. Some delay should be anticipated when ordering these items.

All variable and adjustable resistors have characteristic curve B, unless otherwise noted.

RESISTORS

All resistors are in ohms
F : nonflammable

When indicating parts by reference number, please include the board name.

CAPACITORS
MF : μ F, PF : pF

COILS
MH : mH, UH : μ H

The components identified by \square in this manual have been carefully factory-selected for each set in order to satisfy regulations regarding X-ray radiation. Should replacement be required, replace only with the value originally used.

REF. NO.	PART NO.	DESCRIPTION	REMARK	REF. NO.	PART NO.	DESCRIPTION	REMARK
*A-1135-726-A B BOARD, COMPLETE							

<FILTER>							
	BPFI01	1-236-363-11	FILTER, BAND PASS		C147	1-164-232-11	CERAMIC CHIP 0.01MF 10% 50V
	BPFI02	1-236-304-11	FILTER, BAND PASS		C148	1-126-160-11	ELECT 1MF 20% 50V
<CAPACITOR>							
	C101	1-124-589-11	ELECT 47MF 20% 16V		C149	1-163-022-00	CERAMIC CHIP 0.012MF 10% 50V
	C102	1-124-477-11	ELECT 47MF 20% 16V		C150	1-124-589-11	ELECT 47MF 20% 16V
	C103	1-126-157-11	ELECT 10MF 20% 16V		C151	1-163-131-00	CERAMIC CHIP 390PF 5% 50V
	C106	1-124-477-11	ELECT 47MF 20% 16V		C152	1-163-101-00	CERAMIC CHIP 22PF 5% 50V
	C107	1-163-031-11	CERAMIC CHIP 0.01MF 50V		C153	1-163-125-00	CERAMIC CHIP 220PF 5% 50V
	C108	1-124-477-11	ELECT 47MF 20% 16V		C154	1-163-031-11	CERAMIC CHIP 0.01MF 50V
	C109	1-124-477-11	ELECT 47MF 20% 16V		C155	1-163-133-00	CERAMIC CHIP 470PF 5% 50V
	C110	1-124-120-11	ELECT 220MF 20% 16V		C156	1-164-289-11	CERAMIC CHIP 0.22MF 10% 25V
	C111	1-163-031-11	CERAMIC CHIP 0.01MF 50V		C157	1-163-229-11	CERAMIC CHIP 12PF 5% 50V
	C112	1-163-031-11	CERAMIC CHIP 0.01MF 50V		C158	1-124-477-11	ELECT 47MF 20% 16V
	C113	1-163-031-11	CERAMIC CHIP 0.01MF 50V		C159	1-163-229-11	CERAMIC CHIP 12PF 5% 50V
	C114	1-124-477-11	ELECT 47MF 20% 16V		C160	1-163-229-11	CERAMIC CHIP 12PF 5% 50V
	C115	1-163-031-11	CERAMIC CHIP 0.01MF 50V		C161	1-124-902-00	ELECT 0.47MF 20% 50V
	C116	1-126-154-11	ELECT 47MF 20% 16V		C162	1-124-477-11	ELECT 47MF 20% 16V
	C117	1-126-154-11	ELECT 47MF 20% 16V		C163	1-163-809-11	CERAMIC CHIP 0.047MF 10% 25V
	C118	1-126-154-11	ELECT 47MF 20% 16V		C164	1-163-809-11	CERAMIC CHIP 0.047MF 10% 25V
	C119	1-163-031-11	CERAMIC CHIP 0.01MF 50V		C165	1-163-031-11	CERAMIC CHIP 0.01MF 50V
	C120	1-126-154-11	ELECT 47MF 20% 16V		C166	1-163-031-11	CERAMIC CHIP 0.01MF 50V
	C121	1-124-477-11	ELECT 47MF 20% 16V		C167	1-124-477-11	ELECT 47MF 20% 16V
	C122	1-124-477-11	ELECT 47MF 20% 16V		C168	1-163-031-11	CERAMIC CHIP 0.01MF 50V
	C123	1-163-031-11	CERAMIC CHIP 0.01MF 50V		C169	1-163-243-11	CERAMIC CHIP 47PF 5% 50V
	C124	1-126-154-11	ELECT 47MF 20% 16V		C170	1-163-129-00	CERAMIC CHIP 390PF 5% 50V
	C125	1-126-154-11	ELECT 47MF 20% 16V		C171	1-163-243-11	CERAMIC CHIP 47PF 5% 50V
	C126	1-163-031-11	CERAMIC CHIP 0.01MF 50V		C172	1-163-129-00	CERAMIC CHIP 390PF 5% 50V
	C127	1-126-154-11	ELECT 47MF 20% 16V		C173	1-124-589-11	ELECT 47MF 20% 16V
	C128	1-126-154-11	ELECT 47MF 20% 16V		C174	1-124-477-11	ELECT 47MF 20% 16V
	C129	1-163-031-11	CERAMIC CHIP 0.01MF 50V		C175	1-108-092-00	MILAR 0.001MF 50V
	C130	1-163-031-11	CERAMIC CHIP 0.01MF 50V		C176	1-163-031-11	CERAMIC CHIP 0.01MF 50V
	C131	1-163-031-11	CERAMIC CHIP 0.01MF 50V		C177	1-163-031-11	CERAMIC CHIP 0.01MF 50V
	C132	1-124-589-11	ELECT 47MF 20% 16V		C178	1-163-031-11	CERAMIC CHIP 0.01MF 50V
	C133	1-124-589-11	ELECT 47MF 20% 16V		C179	1-126-160-11	ELECT 1MF 20% 50V
	C134	1-163-275-11	CERAMIC CHIP 0.001MF 5% 50V		C180	1-163-031-11	CERAMIC CHIP 0.01MF 50V
	C135	1-163-113-00	CERAMIC CHIP 68PF 5% 50V		C181	1-126-154-11	ELECT 47MF 20% 16V
	C137	1-163-115-00	CERAMIC CHIP 82PF 5% 50V		C182	1-163-031-11	CERAMIC CHIP 0.01MF 50V
	C138	1-124-589-11	ELECT 47MF 20% 16V		C183	1-164-232-11	CERAMIC CHIP 0.01MF 10% 50V
	C139	1-163-031-11	CERAMIC CHIP 0.01MF 50V		C184	1-163-031-11	CERAMIC CHIP 0.01MF 50V
	C140	1-163-205-00	CERAMIC CHIP 0.001MF 5% 50V		C185	1-163-031-11	CERAMIC CHIP 0.01MF 50V
	C141	1-163-141-00	CERAMIC CHIP 0.001MF 5% 50V		C186	1-163-099-00	CERAMIC CHIP 18PF 5% 50V
	C142	1-163-031-11	CERAMIC CHIP 0.01MF 50V		C187	1-163-031-11	CERAMIC CHIP 0.01MF 50V
	C143	1-163-121-00	CERAMIC CHIP 150PF 5% 50V		C188	1-163-031-11	CERAMIC CHIP 0.01MF 50V
	C144	1-163-101-00	CERAMIC CHIP 390PF 5% 50V		C189	1-163-035-00	CERAMIC CHIP 0.047MF 5% 50V
	C145	1-163-131-00	CERAMIC CHIP 390PF 5% 50V		C190	1-163-121-00	CERAMIC CHIP 150PF 5% 50V
	C146	1-126-157-11	ELECT 10MF 20% 16V		C191	1-163-031-11	CERAMIC CHIP 0.01MF 50V
					C192	1-163-031-11	CERAMIC CHIP 0.01MF 50V
					C193	1-124-589-11	ELECT 47MF 20% 16V
					C194	1-124-589-11	ELECT 47MF 20% 16V
					C195	1-124-589-11	ELECT 47MF 20% 16V
					C196	1-124-589-11	ELECT 47MF 20% 16V
					C197	1-124-589-11	ELECT 47MF 20% 16V

B

B

REMARK	REF. NO.	PART NO.	DESCRIPTION	REMARK	REF. NO.	PART NO.	DESCRIPTION	REMARK	REF. NO.	PART NO.	DESCRIPTION	REMARK	REF. NO.	PART NO.	DESCRIPTION	REMARK
	CN102	1-564-506-11	PLUG, CONNECTOR 3P		JR132	1-216-295-00	METAL GLAZE 0 5%	1/10W		Q141	8-729-422-27	TRANSISTOR 2SD601A-Q		Q142	8-729-422-27	TRANSISTOR 2SD601A-Q
	CN103	1-565-503-11	CONNECTOR, BOARD TO BOARD 12P		JR133	1-216-295-00	METAL GLAZE 0 5%	1/10W		Q143	8-729-422-27	TRANSISTOR 2SD601A-Q		Q144	8-729-422-27	TRANSISTOR 2SD601A-Q
	CN104	1-506-477-11	PIN, CONNECTOR 12P		JR178	1-216-295-00	METAL GLAZE 0 5%	1/10W		Q145	8-729-422-27	TRANSISTOR 2SD601A-Q		Q146	8-729-255-12	TRANSISTOR 2SC2251-Q
	CN105	1-564-509-11	PLUG, CONNECTOR 6P							Q147	8-729-255-12	TRANSISTOR 2SC2251-Q		Q148	8-729-216-22	TRANSISTOR 2SA1162-G
	CN107	1-506-478-11	PIN, CONNECTOR 13P													
			<TRAP MODULE>													
	CR101	1-236-366-11	MODULE, TRAP													
	CR102	1-236-365-11	MODULE, TRAP													
			<TRIMMER>													
	CV101	1-141-418-11	CAP. ADJ													
	CV102	1-141-418-11	CAP. ADJ													
			<DIODE>													
	D104	8-719-404-46	DIODE MA110													
	D105	8-719-404-46	DIODE MA110													
	D106	8-719-404-46	DIODE MA110													
	D107	8-719-404-46	DIODE MA110													
	D108	8-719-404-46	DIODE MA110													
	D109	8-719-404-46	DIODE MA110													
	D110	8-719-404-46	DIODE MA110													
	D111	8-719-404-46	DIODE MA110													
	D112	8-719-404-46	DIODE MA110													
	D113	8-719-404-46	DIODE MA110													
	D117	8-719-404-46	DIODE MA110													
	D120	8-719-404-46	DIODE MA110													
	D121	8-719-404-46	DIODE MA110													
	D122	8-719-404-46	DIODE MA110													
	D123	8-719-404-46	DIODE MA110													
	D125	8-719-404-46	DIODE MA110													
	D126	8-719-404-46	DIODE MA110													
	D127	8-719-404-46	DIODE MA110													
	D128	8-719-400-18	DIODE MAL25M													
	D129	8-719-404-46	DIODE MA110													
	D130	8-719-800-76	DIODE ISS226													
	D131	8-719-800-76	DIODE ISS226													
	D132	8-719-800-76	DIODE ISS226													
	D133	8-719-404-46	DIODE MA110													
	D134	8-719-404-46	DIODE MA110													
	D135	8-719-404-46	DIODE MA110													
	D136	8-719-404-46	DIODE MA110													
	D137	8-719-404-46	DIODE MA110													
	D138	8-719-404-46	DIODE MA110													
	D139	8-719-404-46	DIODE MA110													
	D144	8-719-404-46	DIODE MA110													
	D145	8-719-404-46	DIODE MA110													
	D146	8-719-404-46	DIODE MA110													
	D147	8-719-404-46	DIODE MA110													
	D148	8-719-404-46	DIODE MA110													
	D149	8-719-404-46	DIODE MA110													
	D150	8-719-404-46	DIODE MA110													
	D151	8-719-404-46	DIODE MA110													
	D152	8-719-404-46	DIODE MA110													
	D153	8-719-977-20	DIODE DTZ8_28													
	D154	8-719-404-46	DIODE MA110													
	D155	8-719-404-46	DIODE MA110													
	D156	8-719-404-46	DIODE MA110													
	D157	8-719-901-83	DIODE ISS83													
	D158	8-719-901-83	DIODE ISS83													
	D159	8-719-901-83	DIODE ISS83													
	D160	8-719-404-46	DIODE MA110													
	D161	8-719-404-46	DIODE MA110													
	D162	8-719-404-46	DIODE MA110													
	D170	8-719-404-46	DIODE MA110													
	D185	8-719-104-34	DIODE IS2836													
	D186	8-719-400-18	DIODE MAL25M													
	D187	8-719-800-76	DIODE ISS226													
	D188	8-719-800-76	DIODE ISS226													
	D191	8-719-104-34	DIODE IS2836													
	D285	8-719-404-46	DIODE MA110													
	D289	8-719-404-46	DIODE MA110													
	D341	8-719-404-46	DIODE MA110													
	D342	8-719-104-34	DIODE IS2836													
	D343	8-719-800-76	DIODE ISS226													
	D344	8-719-105-XX	DIODE R06_2M-B1													
	D345	8-719-901-83	DIODE ISS83													
	D346	8-719-901-83	DIODE ISS83													
	D347	8-719-901-83	DIODE ISS83													
	D348	8-719-800-76	DIODE ISS226													
	D349	8-719-800-76	DIODE ISS226													
	D350	8-719-800-76	DIODE ISS226													
	D390	8-719-800-76	DIODE ISS226													
	D393	8-719-404-46	DIODE MA110													
	D1582	8-719-104-34	DIODE IS2836													
			<DELAY LINE>													
	DL101	1-415-632-11	DELAY LINE, Y													
			<I>													
	IC102	8-759-501-21	IC MM1149XF													
	IC103	8-759-501-21	IC MM1149XF													
	IC104	8-759-048-09	IC MM1148XF													
	IC105	8-759-048-09	IC MM1148XF													
	IC106	8-759-009-51	IC MC14538BF													
	IC107	8-759-509-57	IC XRU4584BF													
	IC108	8-759-509-17	IC XRU4053BF													
	IC109	8-759-509-37	IC XRU4070BF													
	IC110	8-759-509-17	IC XRU4053BF													
	IC111	8-759-509-17	IC XRU4053BF													
	IC112	8-759-924-12	IC LM7805CT													
	IC113	8-759-631-08	IC W51279FF													
	IC114	8-759-509-13	IC XRU4052BF													
	IC115	8-759-509-13	IC XRU4052BF													
	IC116	8-759-509-05	IC XRU4066BF													
	IC117	8-759-711-32	IC NJM2245M													
	IC118	8-759-711-32	IC NJM2													

REF. NO.	PART NO.	DESCRIPTION	REMARK	REF. NO.	PART NO.	DESCRIPTION	REMARK
R104	1-216-061-00	METAL GLAZE	3.3K 5%	1/10W	R185	1-216-073-00	METAL GLAZE 10K 5% 1/10W
R105	1-216-025-00	METAL GLAZE	100 5%	1/10W	R186	1-216-113-00	METAL GLAZE 470K 5% 1/10W
R106	1-216-065-00	METAL GLAZE	4.7K 5%	1/10W	R187	1-216-073-00	METAL GLAZE 10K 5% 1/10W
R107	1-216-025-00	METAL GLAZE	100 5%	1/10W	R188	1-216-113-00	METAL GLAZE 470K 5% 1/10W
R108	1-216-113-00	METAL GLAZE	470K 5%	1/10W	R189	1-216-103-00	METAL GLAZE 180K 5% 1/10W
R109	1-216-065-00	METAL GLAZE	4.7K 5%	1/10W	R190	1-216-107-00	METAL GLAZE 270K 5% 1/10W
R110	1-216-049-00	METAL GLAZE	1K 5%	1/10W	R191	1-216-097-00	METAL GLAZE 100K 5% 1/10W
R111	1-216-063-00	METAL GLAZE	3.9K 5%	1/10W	R192	1-216-103-00	METAL GLAZE 180K 5% 1/10W
R112	1-216-049-00	METAL GLAZE	1K 5%	1/10W	R193	1-216-105-00	METAL GLAZE 220K 5% 1/10W
R113	1-249-401-11	CARBON	47 5%	1/4W	R194	1-216-089-00	METAL GLAZE 47K 5% 1/10W
R114	1-216-045-00	METAL GLAZE	680 5%	1/10W	R195	1-216-113-00	METAL GLAZE 470K 5% 1/10W
R115	1-216-061-00	METAL GLAZE	3.3K 5%	1/10W	R196	1-216-073-00	METAL GLAZE 10K 5% 1/10W
R117	1-216-073-00	METAL GLAZE	10K 5%	1/10W	R197	1-216-671-11	METAL CHIP 6.8K 0.50% 1/10W
R118	1-216-025-00	METAL GLAZE	100 5%	1/10W	R198	1-216-049-00	METAL GLAZE 1K 5% 1/10W
R119	1-216-647-11	METAL CHIP	680 0.50%	1/10W	R199	1-216-065-00	METAL GLAZE 4.7K 5% 1/10W
R120	1-216-647-11	METAL CHIP	680 0.50%	1/10W	R200	1-216-065-00	METAL GLAZE 4.7K 5% 1/10W
R121	1-216-025-00	METAL GLAZE	100 5%	1/10W	R201	1-216-043-00	METAL GLAZE 560 5% 1/10W
R123	1-216-073-00	METAL GLAZE	10K 5%	1/10W	R202	1-216-033-00	METAL GLAZE 220 5% 1/10W
R124	1-216-073-00	METAL GLAZE	10K 5%	1/10W	R203	1-216-045-00	METAL GLAZE 680 5% 1/10W
R125	1-216-083-00	METAL GLAZE	27K 5%	1/10W	R204	1-216-073-00	METAL GLAZE 10K 5% 1/10W
R126	1-216-093-00	METAL GLAZE	68K 5%	1/10W	R205	1-216-073-00	METAL GLAZE 10K 5% 1/10W
R127	1-216-037-00	METAL GLAZE	330 5%	1/10W	R206	1-216-043-00	METAL GLAZE 560 5% 1/10W
R128	1-216-083-00	METAL GLAZE	27K 5%	1/10W	R207	1-216-045-00	METAL GLAZE 680 5% 1/10W
R129	1-216-067-00	METAL GLAZE	5.6K 5%	1/10W	R208	1-216-671-11	METAL CHIP 6.8K 0.50% 1/10W
R130	1-216-097-00	METAL GLAZE	100K 5%	1/10W	R209	1-216-043-00	METAL GLAZE 560 5% 1/10W
R136	1-216-091-00	METAL GLAZE	56K 5%	1/10W	R210	1-216-033-00	METAL GLAZE 220 5% 1/10W
R137	1-216-045-00	METAL GLAZE	680 5%	1/10W	R211	1-216-099-00	METAL GLAZE 120K 5% 1/10W
R138	1-216-657-11	METAL CHIP	1.8K 0.50%	1/10W	R212	1-216-065-00	METAL GLAZE 4.7K 5% 1/10W
R139	1-216-079-00	METAL GLAZE	18K 5%	1/10W	R213	1-216-043-00	METAL GLAZE 560 5% 1/10W
R140	1-216-653-11	METAL CHIP	1.2K 0.50%	1/10W	R214	1-216-043-00	METAL GLAZE 560 5% 1/10W
R141	1-216-063-00	METAL GLAZE	3.9K 5%	1/10W	R215	1-216-127-11	METAL GLAZE 1.8M 5% 1/10W
R143	1-216-073-00	METAL GLAZE	10K 5%	1/10W	R216	1-216-043-00	METAL GLAZE 560 5% 1/10W
R143	1-216-085-00	METAL GLAZE	33K 5%	1/10W	R217	1-216-033-00	METAL GLAZE 220 5% 1/10W
R144	1-216-089-00	METAL GLAZE	47K 5%	1/10W	R218	1-216-295-00	METAL GLAZE 0 5% 1/10W
R145	1-216-065-00	METAL GLAZE	4.7K 5%	1/10W	R219	1-216-043-00	METAL GLAZE 560 5% 1/10W
R146	1-216-037-00	METAL CHIP	330 5%	1/10W	R220	1-216-043-00	METAL GLAZE 560 5% 1/10W
R148	1-216-671-11	METAL CHIP	6.8K 0.50%	1/10W	R221	1-216-035-00	METAL GLAZE 270 5% 1/10W
R155	1-216-055-11	METAL CHIP	1.5K 0.50%	1/10W	R222	1-216-033-00	METAL GLAZE 220 5% 1/10W
R157	1-216-679-11	METAL CHIP	15K 0.50%	1/10W	R223	1-216-073-00	METAL GLAZE 10K 5% 1/10W
R158	1-216-677-11	METAL CHIP	12K 0.50%	1/10W	R224	1-216-073-00	METAL GLAZE 10K 5% 1/10W
R160	1-216-065-00	METAL GLAZE	4.7K 5%	1/10W	R225	1-216-095-00	METAL GLAZE 82K 5% 1/10W
R161	1-216-089-00	METAL GLAZE	47K 5%	1/10W	R226	1-216-073-00	METAL GLAZE 10K 5% 1/10W
R163	1-216-073-00	METAL GLAZE	10K 5%	1/10W	R227	1-216-095-00	METAL GLAZE 270 5% 1/10W
R164	1-216-677-11	METAL CHIP	12K 0.50%	1/10W	R228	1-216-065-00	METAL GLAZE 4.7K 5% 1/10W
R165	1-216-107-00	METAL GLAZE	270K 5%	1/10W	R229	1-216-113-00	METAL GLAZE 470K 5% 1/10W
R166	1-216-681-11	METAL CHIP	18K 0.50%	1/10W	R230	1-216-081-00	METAL GLAZE 22K 5% 1/10W
R167	1-216-635-11	METAL CHIP	220 0.50%	1/10W	R231	1-216-113-00	METAL GLAZE 470K 5% 1/10W
R168	1-216-103-00	METAL GLAZE	180K 5%	1/10W	R232	1-216-105-00	METAL GLAZE 220K 5% 1/10W
R169	1-216-033-00	METAL GLAZE	220 5%	1/10W	R233	1-216-073-00	METAL GLAZE 10K 5% 1/10W
R170	1-216-083-00	METAL GLAZE	47K 5%	1/10W	R234	1-216-041-00	METAL GLAZE 470 5% 1/10W
R171	1-216-053-00	METAL GLAZE	1.5K 5%	1/10W	R235	1-216-041-00	METAL GLAZE 470 5% 1/10W
R172	1-216-043-00	METAL GLAZE	560 5%	1/10W	R236	1-216-077-00	METAL GLAZE 15K 5% 1/10W
R173	1-216-093-00	METAL GLAZE	68K 5%	1/10W	R237	1-216-025-00	METAL GLAZE 100 5% 1/10W
R174	1-216-069-00	METAL GLAZE	6.8K 5%	1/10W	R238	1-216-065-00	METAL GLAZE 4.7K 5% 1/10W
R175	1-216-057-00	METAL GLAZE	2.2K 5%	1/10W	R239	1-216-065-00	METAL GLAZE 4.7K 5% 1/10W
R176	1-216-065-00	METAL GLAZE	4.7K 5%	1/10W	R240	1-216-033-00	METAL GLAZE 220 5% 1/10W
R177	1-216-073-00	METAL GLAZE	10K 5%	1/10W	R241	1-216-073-00	METAL GLAZE 10K 5% 1/10W
R178	1-216-089-00	METAL GLAZE	47K 5%	1/10W	R242	1-216-051-00	METAL GLAZE 1.2K 1/10W
R179	1-216-081-00	METAL GLAZE	22K 5%	1/10W	R243	1-216-113-00	METAL GLAZE 470K 5% 1/10W
R180	1-216-675-11	METAL CHIP	15K 0.50%	1/10W	R244	1-216-065-00	METAL GLAZE 4.7K 5% 1/10W
R181	1-216-071-00	METAL GLAZE	8.2K 5%	1/10W	R245	1-216-679-11	METAL CHIP 15K 0.50% 1/10W
R182	1-216-683-11	METAL CHIP	22K 0.50%	1/10W	R246	1-216-103-00	METAL GLAZE 180K 5% 1/10W
R183	1-216-691-11	METAL CHIP	47K 0.50%	1/10W	R247	1-216-093-00	METAL GLAZE 68K 5% 1/10W
R184	1-216-699-11	METAL CHIP	100K 0.50%	1/10W			

B

REF. NO.	PART NO.	DESCRIPTION	REMARK	REF. NO.	PART NO.	DESCRIPTION	REMARK	
R248	1-216-095-00	METAL GLAZE	82K 5%	1/10W	R319	1-216-099-00	METAL GLAZE 120K 5% 1/10W	
R249	1-216-109-00	METAL GLAZE	330K 5%	1/10W	R320	1-216-099-00	METAL GLAZE 120K 5% 1/10W	
R250	1-216-101-00	METAL GLAZE	150K 5%	1/10W	R321	1-216-043-00	METAL GLAZE 560 5% 1/10W	
R251	1-216-105-00	METAL GLAZE	220K 5%	1/10W	R325	1-216-097-00	METAL GLAZE 100K 5% 1/10W	
R252	1-216-101-00	METAL GLAZE	150K 5%	1/10W	R326	1-216-113-00	METAL GLAZE 470K 5% 1/10W	
R253	1-216-101-00	METAL GLAZE	150K 5%	1/10W	R328	1-216-073-00	METAL GLAZE 10K 5% 1/10W	
R254	1-216-033-00	METAL GLAZE	220 5%	1/10W	R329	1-216-107-00	METAL GLAZE 270K 5% 1/10W	
R255	1-216-061-00	METAL GLAZE	3.3K 5%	1/10W	R330	1-216-105-00	METAL GLAZE 220K 5% 1/10W	
R256	1-216-107-00	METAL GLAZE	270K 5%	1/10W	R331	1-216-025-00	METAL GLAZE 100 5% 1/10W	
R258	1-216-041-00	METAL GLAZE	470 5%	1/10W	R332	1-216-097-00	METAL GLAZE 100K 5% 1/10W	
R259	1-216-073-00	METAL GLAZE	10K 5%	1/10W	R333	1-216-097-00	METAL GLAZE 100K 5% 1/10W	
R260	1-216-025-00	METAL GLAZE	100 5%	1/10W	R334	1-216-025-00	METAL GLAZE 100 5% 1/10W	
R261	1-216-035-00	METAL GLAZE	270 5%	1/10W	R335	1-216-099-00	METAL GLAZE 120K 5% 1/10W	
R262	1-216-097-00	METAL GLAZE	100K 5%	1/10W	R336	1-216-095-00	METAL GLAZE 82K 5% 1/10W	
R263	1-216-029-00	METAL GLAZE	150 5%	1/10W	R338	1-216-025-00	METAL GLAZE 100 5% 1/10W	
R264	1-216-065-00	METAL GLAZE	4.7K 5%	1/10W	R339	1-216-099-00	METAL GLAZE 120K 5% 1/10W	
R265	1-216-067-00	METAL GLAZE	5.6K 5%	1/10W	R340	1-216-095-00	METAL GLAZE 82K 5% 1/10W	
R266	1-216-073-00	METAL GLAZE	10K 5%	1/10W	R342	1-216-047-00	METAL GLAZE 820 5% 1/10W	
R267	1-216-073-00	METAL GLAZE	10K 5%	1/10W	R343	1-216-053-00	METAL GLAZE 1.5K 5% 1/10W	
R268	1-216-081-00	METAL GLAZE	22K 5%	1/10W	R344	1-216-664-11	METAL CHIP 3.6K 0.50K 1/10W	
R269	1-216-103-00	METAL GLAZE	180K 5%	1/10W	R345	1-216-661-11	METAL CHIP 2.7K 0.50K 1/10W	
R270	1-216-081-00	METAL GLAZE	22K 5%	1/10W	R346	1-216-105-00	METAL GLAZE 220K 5% 1/10W	
R271	1-216-025-00	METAL GLAZE	100 5%	1/10W	R348	1-216-061-00	METAL GLAZE 3.3K 5% 1/10W	
R272	1-216-103-00	METAL GLAZE	180K 5%	1/10W	R349	1-216-650-11	METAL CHIP 910 0.50K 1/10W	
R273	1-216-113-00	METAL GLAZE	470K 5%	1/10W	R350	1-216-653-11	METAL CHIP 1.2K 0.50K 1/10W	
R275	1-216-081-00	METAL GLAZE	22K 5%	1/10W	R351	1-216-650-11	METAL CHIP 910 0.50K 1/10W	
R276	1-216-037-00	METAL GLAZE	330 5%	1/10W	R352	1-216-653-11	METAL CHIP 1.2K 0.50K 1/10W	
R277	1-216-049-00	METAL GLAZE	1K 5%	1/10W	R353	1-216-650-11	METAL CHIP 910 0.50K 1/10W	
R278	1-216-059-00	METAL GLAZE	2.7K 5%	1/10W	R354	1-216-653-11	METAL CHIP 1.2K 0.50K 1/10W	
R280	1-216-061-00	METAL GLAZE	3.3K 5%	1/10W	R355	1-216-113-00	METAL GLAZE 470K 5% 1/10W	
R281	1-216-061-00	METAL GLAZE	3.3K 5%	1/10W	R356	1-216-113-00	METAL GLAZE 470K 5% 1/10W	
R282	1-216-037-00	METAL GLAZE	330 5%	1/10W	R357	1-216-095-00	METAL GLAZE 82K 5% 1/10W	
R283	1-216-049-00	METAL GLAZE	1K 5%	1/10W	R358	1-216-113-00	METAL GLAZE 470K 5% 1/10W	
R284	1-216-059-00	METAL GLAZE	2.7K 5%	1/10W	R359	1-216-081-00	METAL GLAZE 22K 5% 1/10W	
R286	1-216-061-00	METAL GLAZE	3.3K 5%	1/10W	R360	1-216-089-00	METAL GLAZE 47K 5% 1/10W	
R287	1-216-061-00	METAL GLAZE	3.3K 5%	1/10W	R363	1-216-069-00	METAL GLAZE 6.8K 5% 1/10W	
R288	1-216-037-00	METAL GLAZE	330 5%	1/10W	R364	1-216-073-00	METAL GLAZE 10K 5% 1/10W	
R289	1-216-049-00	METAL GLAZE	1K 5%	1/10W	R365	1-216-073-00	METAL GLAZE 10K 5% 1/10W	
R290	1-216-059-00	METAL GLAZE	2.7K 5%	1/10W	R366	1-216-244-00	METAL GLAZE 82K 5% 1/8W	
R292	1-216-061-00	METAL GLAZE	3.3K 5%	1/10W	R367	1-216-244-00	METAL GLAZE 82K 5% 1/8W	
R293	1-216-061-00	METAL GLAZE	3.3K 5%	1/10W	R368	1-216-055-00	METAL GLAZE 1.8K 5% 1/10W	
R295	1-216-057-00	METAL GLAZE	2.2K 5%	1/10W	R369	1-216-248-00	METAL GLAZE 120K 5% 1/8W	
R296	1-216-659-11	METAL CHIP	2.2K 0.50K	1/10W	R370	1-216-115-00	METAL GLAZE 560K 5% 1/10W	
R297	1-216-659-11	METAL CHIP	2.2K 0.50K	1/10W	R371	1-216-067-00	METAL GLAZE 5.6K 5% 1/10W	
R298	1-216-065-00	METAL GLAZE	4.7K 5%	1/10W	R372	1-216-115-00	METAL GLAZE 560K 5% 1/10W	
R300	1-216-065-00	METAL GLAZE	4.7K 5%	1/10W	R374	1-216-115-00	METAL GLAZE 560K 5% 1/10W	
R301	1-216-065-00	METAL GLAZE	4.7K 5%	1/10W	R375	1-216-683-11	METAL CHIP 22K 0.50K 1/10W	
R302	1-216-113-00	METAL GLAZE	470K 5%	1/10W	R376	1-216-663-11	METAL CHIP 3.3K 0.50K 1/10W	
R303	1-216-065-00	METAL GLAZE	4.7K 5%	1/10W	R378	1-216-025-00	METAL GLAZE 100 5% 1/10W	
R304	1-216-049-00	METAL GLAZE	1K 5%	1/10W	R379	1-216-641-11	METAL CHIP 390 0.50K 1/10W	
R305	1-216-049-00	METAL GLAZE	1K 5%	1/10W	R380	1-216-668-11	METAL CHIP 5.1K 0.50K 1/10W	
R306	1-216-089-00	METAL GLAZE	47K 5%	1/10W	R381	1-216-089-00	METAL GLAZE 47K 5% 1/10W	
R307	1-216-033-00	METAL GLAZE	220 5%	1/10W	R382	1-216-025-00	METAL GLAZE 100 5% 1/10W	
R308	1-216-089-00	METAL GLAZE	47K 5%	1/10W	R383	1-216-641-11	METAL CHIP 390 0.50K 1/10W	
R309	1-216-089-00	METAL GLAZE	47K 5%	1/10W	R384	1-216-668-11	METAL CHIP 5.1K 0.50K 1/10W	
R310	1-216-033-00	METAL GLAZE	220 5%	1/10W	R385	1-216-117-00	METAL GLAZE 680K 5% 1/10W	
R311	1-216-089-00	METAL GLAZE	47K 5%	1/10W	R386	1-216-025-00	METAL GLAZE 100 5% 1/10W	
R312	1-216-089-00	METAL GLAZE	47K 5%	1/10W	R387	1-216-641-11	METAL CHIP 390 0.50K 1/10W	
R313	1-216-033-00	METAL GLAZE	220 5%	1/10W	R388	1-216-668-11	METAL CHIP 5.1K 0.50K 1/10W	
R314	1-216-089-00	METAL GLAZE	47K 5%	1/10W	R389	1-216-089-00	METAL GLAZE 47K 5% 1/10W	
R315	1-216-113-00	METAL GLAZE	470K 5%	1/10W	R390	1-216-105-00	METAL GLAZE 220K 5% 1/10W	
R316	1-216-105-00	METAL GLAZE	220K 5%	1/10W	R391	1-216-081-00	METAL GLAZE 22K 5% 1/10W	
R317	1-216-109-00	METAL GLAZE	330K 5%	1/10W	R392	1-216-113-00	METAL GLAZE 470K 5% 1/10W	
R318	1-216-105-00	METAL GLAZE	220K 5%	1/10W				

REF. NO.	PART NO.	DESCRIPTION	REMARK	REF. NO.	PART NO.	DESCRIPTION	REMARK
R393	1-216-085-00	METAL GLAZE	33K 5%	1/10W	R1070	1-216-085-00	METAL GLAZE 33K 5% 1/10W
R394	1-216-121-00	METAL GLAZE	1W 5%	1/10W	R1071	-216-113-00	METAL GLAZE 470K 5% 1/10W
R397	1-249-437-11	CARBON	47K 5%	1/4W F	R1072	-216-099-00	METAL GLAZE 126K 5% 1/10W
R398	1-249-434-11	CARBON	27R 5%	1/4W F	R1073	-216-131-11	METAL GLAZE 2.7M 5% 1/10W
R399	1-216-073-00	METAL GLAZE	10K 5%	1/10W	R1075	-216-065-00	METAL GLAZE 4.7K 5% 1/10W
R1001	1-216-073-00	METAL GLAZE	10K 5%	1/10W	R1076	-216-101-00	METAL GLAZE 150K 5% 1/10W
R1002	1-216-047-00	METAL GLAZE	820 5%	1/10W	R1077	-216-103-00	METAL GLAZE 180K 5% 1/10W
R1003	1-216-055-00	METAL GLAZE	1.8K 5%	1/10W	R1078	-216-085-00	METAL GLAZE 33K 5% 1/10W
R1004	1-216-061-00	METAL GLAZE	3.3K 5%	1/10W	R1079	-216-073-00	METAL GLAZE 10K 5% 1/10W
R1005	1-216-047-00	METAL GLAZE	820 5%	1/10W	R1080	-216-097-00	METAL GLAZE 100K 5% 1/10W
R1006	1-216-055-00	METAL GLAZE	1.8K 5%	1/10W	R1081	-216-097-00	METAL GLAZE 100K 5% 1/10W
R1007	1-216-061-00	METAL GLAZE	3.3K 5%	1/10W	R1083	-216-065-00	METAL GLAZE 4.7K 5% 1/10W
R1008	1-216-047-00	METAL GLAZE	820 5%	1/10W	R1084	-216-063-00	METAL GLAZE 3.9K 5% 1/10W
R1009	1-216-055-00	METAL GLAZE	1.8K 5%	1/10W	R1088	-216-047-00	METAL GLAZE 820 5% 1/10W
R1010	1-216-061-00	METAL GLAZE	3.3K 5%	1/10W	R1090	-216-045-00	METAL GLAZE 680 5% 1/10W
R1011	1-216-033-00	METAL GLAZE	220 5%	1/10W	R1091	-216-045-00	METAL GLAZE 680 5% 1/10W
R1012	1-216-051-00	METAL GLAZE	1.2K 5%	1/10W	R1092	-216-045-00	METAL GLAZE 680 5% 1/10W
R1013	1-216-051-00	METAL GLAZE	1.2P 5%	1/10W	R1093	-216-121-00	METAL GLAZE 1W 5% 1/10W
R1014	1-216-246-00	METAL GLAZE	100K 5%	1/8W	R1094	-216-075-00	METAL GLAZE 12K 5% 1/10W
R1015	1-216-033-00	METAL GLAZE	220 5%	1/10W	R1095	-216-075-00	METAL GLAZE 12K 5% 1/10W
R1016	1-216-089-00	METAL GLAZE	47K 5%	1/10W	R1096	-216-075-00	METAL GLAZE 12K 5% 1/10W
R1017	1-216-045-00	METAL GLAZE	680 5%	1/10W	R1200	-216-699-11	METAL CHIP 100K 0.50% 1/10W
R1018	1-216-043-00	METAL GLAZE	560 5%	1/10W	R1201	-218-754-11	METAL CHIP 120K 0.50% 1/10W
R1019	1-216-033-00	METAL GLAZE	220 5%	1/10W	R1207	-216-061-00	METAL GLAZE 3.3K 5% 1/10W
R1020	1-216-089-00	METAL GLAZE	47K 5%	1/10W	R1208	-216-065-00	METAL GLAZE 4.7K 5% 1/10W
R1021	1-216-045-00	METAL GLAZE	680 5%	1/10W	R1220	-216-059-00	METAL GLAZE 2.7K 5% 1/10W
R1022	1-216-025-00	METAL GLAZE	100 5%	1/10W	R1221	-216-059-00	METAL GLAZE 2.7K 5% 1/10W
R1023	1-216-073-00	METAL GLAZE	10K 5%	1/10W	R1222	-216-059-00	METAL GLAZE 2.7K 5% 1/10W
R1024	1-216-025-00	METAL GLAZE	100 5%	1/10W	R1223	-216-689-11	METAL GLAZE 35K 5% 1/10W
R1025	1-216-033-00	METAL GLAZE	220 5%	1/10W	R1225	-215-876-00	METAL OXIDE 15K 5% 1/10W
R1026	1-216-061-00	METAL GLAZE	3.3K 5%	1/10W	R1226	-215-876-00	METAL OXIDE 15K 5% 1W F
R1027	1-216-101-00	METAL GLAZE	150K 5%	1/10W	R1227	-215-876-00	METAL OXIDE 15K 5% 1W F
R1028	1-216-033-00	METAL GLAZE	220 5%	1/10W	R1228	-249-421-11	CARBON 2.2K 5% 1/4W F
R1029	1-216-061-00	METAL GLAZE	3.3K 5%	1/10W	R1229	-249-421-11	CARBON 2.2K 5% 1/4W F
R1031	1-216-033-00	METAL GLAZE	220 5%	1/10W	R1230	-249-421-11	CARBON 2.2K 5% 1/4W F
R1032	1-216-061-00	METAL GLAZE	3.3K 5%	1/10W	R1231	-216-031-00	METAL GLAZE 180 5% 1/10W
R1033	1-216-081-00	METAL GLAZE	22K 5%	1/10W	R1232	-216-031-00	METAL GLAZE 180 5% 1/10W
R1034	1-216-089-00	METAL GLAZE	47K 5%	1/10W	R1233	-216-031-00	METAL GLAZE 180 5% 1/10W
R1035	1-216-073-00	METAL GLAZE	10K 5%	1/10W	R1234	-216-031-00	METAL GLAZE 180 5% 1/10W
R1036	1-216-089-00	METAL GLAZE	47K 5%	1/10W	R1235	-216-031-00	METAL GLAZE 180 5% 1/10W
R1038	1-216-081-00	METAL GLAZE	22K 5%	1/10W	R1236	-216-031-00	METAL GLAZE 180 5% 1/10W
R1040	1-216-025-00	METAL GLAZE	100 5%	1/10W	R1237	-249-419-11	CARBON 1.5K 5% 1/4W F
R1042	1-216-047-00	METAL GLAZE	820 5%	1/10W	R1238	-249-419-11	CARBON 1.5K 5% 1/4W F
R1043	1-216-057-00	METAL GLAZE	2.2K 5%	1/10W	R1239	-249-419-11	CARBON 1.5K 5% 1/4W F
R1044	1-216-061-00	METAL GLAZE	3.3K 5%	1/10W	R1270	-216-079-00	METAL GLAZE 18K 5% 1/10W
R1045	1-216-125-00	METAL GLAZE	1.5H 5%	1/10W	R1280	-216-109-00	METAL GLAZE 330K 5% 1/10W
R1046	1-216-689-11	METAL CHIP	35K 0.50%	1/10W	R1290	-216-071-00	METAL GLAZE 8.2K 5% 1/10W
R1047	1-216-065-00	METAL GLAZE	4.7K 5%	1/10W	R1291	-216-081-00	METAL GLAZE 22K 5% 1/10W
R1048	1-216-049-00	METAL GLAZE	1K 5%	1/10W	R1294	-216-069-00	METAL GLAZE 6.8K 5% 1/10W
R1049	1-216-085-00	METAL GLAZE	33K 5%	1/10W	R1295	-216-109-00	METAL GLAZE 330K 5% 1/10W
R1050	1-216-059-00	METAL GLAZE	2.7K 5%	1/10W	R1296	-216-095-00	METAL GLAZE 82K 5% 1/10W
R1051	1-216-105-00	METAL GLAZE	220K 5%	1/10W	R1297	-216-077-00	METAL GLAZE 15K 5% 1/10W
R1058	1-216-109-00	METAL GLAZE	330K 5%	1/10W	R1298	-216-077-00	METAL GLAZE 15K 5% 1/10W
R1059	1-216-109-00	METAL GLAZE	330K 5%	1/10W	R1299	-216-075-00	METAL GLAZE 12K 5% 1/10W
R1060	1-216-109-00	METAL GLAZE	330K 5%	1/10W	R1300	-216-089-00	METAL GLAZE 47K 5% 1/10W
R1061	1-216-109-00	METAL GLAZE	330K 5%	1/10W	R1301	-216-065-00	METAL GLAZE 4.7K 5% 1/10W
R1062	1-216-103-00	METAL GLAZE	180K 5%	1/10W	R1302	-216-113-00	METAL GLAZE 470K 5% 1/10W
R1063	1-216-103-00	METAL GLAZE	180K 5%	1/10W	R1303	-216-113-00	METAL GLAZE 470K 5% 1/10W
R1064	1-216-103-00	METAL GLAZE	180K 5%	1/10W	R1304	-216-093-00	METAL GLAZE 68K 5% 1/10W
R1065	1-216-103-00	METAL GLAZE	180K 5%	1/10W	R1305	-216-686-11	METAL CHIP 30K 0.50% 1/10W
R1066	1-216-073-00	METAL GLAZE	10K 5%	1/10W	R1306	-216-063-00	METAL GLAZE 3.9K 5% 1/10W
R1067	1-216-073-00	METAL GLAZE	10K 5%	1/10W	R1307	1-216-041-00	METAL GLAZE 470 5% 1/10W
R1068	1-216-049-00	METAL GLAZE	1K 5%	1/10W	R1308	-216-041-00	METAL GLAZE 470 5% 1/10W
R1069	1-216-133-00	METAL GLAZE	3.3H 5%	1/10W			

The components identified by shading and mark Δ are critical for safety.
Replace only with part number specified.

Les composants identifiés par une trame et une marque Δ sont critiques pour la sécurité. Ne les remplacer que par une pièce portant le numéro spécifié.

REF. NO.	PART NO.	DESCRIPTION	REMARK	REF. NO.	PART NO.	DESCRIPTION	REMARK
C535	1-136-161-00	FILM	0.047MF	5%	50V		
C536	1-124-927-11	ELECT	4.7MF	20%	50V		
C537	1-124-510-11	ELECT	220MF	20%	35V		
C538	1-124-910-11	ELECT	47MF	20%	50V		
C539	1-136-828-11	FILM	1.8MF	5%	200V		
C540	1-163-017-00	CERAMIC CHIP	0.0047MF	10%	50V		
C541	1-163-035-00	CERAMIC CHIP	0.047MF	10%	50V		
C542	1-126-103-11	ELECT	470MF	20%	16V		
C545	1-126-101-11	ELECT	100MF	20%	16V		
C546	1-124-907-11	ELECT	10MF	20%	50V		
C547	1-124-907-11	ELECT	10MF	20%	50V		
C548	1-124-907-11	ELECT	10MF	20%	50V		
C549	1-124-907-11	ELECT	10MF	20%	50V		
C550	1-124-907-11	ELECT	10MF	20%	50V		
C551	1-124-927-11	ELECT	4.7MF	20%	50V		
C552	1-101-004-00	CERAMIC	0.01MF	5%	50V		
C553	1-126-103-11	ELECT	470MF	20%	16V		
C563	1-106-383-00	MYLAR	0.047MF	10%	100V		
C564	1-163-009-11	CERAMIC CHIP	0.001MF	10%	50V		
C567	1-123-875-11	ELECT	10MF	20%	50V		
C568	1-130-736-11	FILM	0.01MF	5%	50V		
C569	1-130-471-00	FILM	0.001MF	5%	50V		
C570	1-163-117-00	CERAMIC CHIP	100PF	5%	50V		
C571	1-124-913-11	ELECT	470MF	20%	50V		
C572	1-101-004-00	CERAMIC	0.01MF	5%	50V		
C574	1-106-351-00	MYLAR	0.0022MF	10%	100V		
C575	1-106-351-00	MYLAR	0.0022MF	10%	100V		
C831	1-123-875-11	ELECT	10MF	20%	50V		
C832	1-123-875-11	ELECT	10MF	20%	50V		
C833	1-163-009-11	CERAMIC CHIP	0.001MF	10%	50V		
C834	1-163-121-00	CERAMIC CHIP	150PF	5%	50V		
C835	1-163-209-00	CERAMIC CHIP	0.0015MF	5%	50V		
C836	1-123-875-11	ELECT	10MF	20%	50V		
C837	1-163-209-00	CERAMIC CHIP	0.0015MF	5%	50V		
C838	1-136-163-00	FILM	0.068MF	5%	50V		
C839	1-102-122-00	CERAMIC	0.0027MF	10%	50V		
C840	1-163-209-00	CERAMIC CHIP	0.0015MF	5%	50V		
C841	1-163-209-00	CERAMIC CHIP	0.0015MF	5%	50V		
C843	1-124-042-51	ELECT	0.47MF	20%	50V		
C844	1-124-902-00	ELECT	0.47MF	20%	50V		
C845	1-124-126-00	ELECT	47MF	20%	10V		
C846	1-124-907-11	ELECT	10MF	20%	50V		
C847	1-126-233-11	ELECT	22MF	20%	50V		
C848	1-131-351-00	TANTALUM	4.7MF	10%	35V		
C849	1-164-182-11	CERAMIC CHIP	0.0033MF	10%	50V		
C1601	1-124-907-11	ELECT	10MF	20%	50V		
C1602	1-164-161-11	CERAMIC CHIP	0.0022MF	10%	50V		
C1603	1-104-348-11	ELECT	15MF	20%	50V		
C1604	1-128-500-51	ELECT	1000MF	20%	50V		
C1605	1-124-922-11	ELECT	1000MF	20%	50V		
C1606	1-163-009-11	CERAMIC CHIP	0.001MF	10%	50V		
C1607	1-124-907-11	ELECT	10MF	20%	50V		
C1608	1-124-916-11	ELECT	22MF	20%	50V		
C1609	1-163-009-11	CERAMIC CHIP	0.001MF	10%	50V		
C1610	1-126-163-11	ELECT	4.7MF	20%	50V		
C1611	1-124-482-11	ELECT	33MF	20%	35V		
C1612	1-136-257-00	FILM	0.0039MF	5%	50V		
C1613	1-163-009-11	CERAMIC CHIP	0.001MF	10%	50V		
C1614	1-164-232-11	CERAMIC CHIP	0.01MF	10%	50V		
C1615	1-124-042-51	ELECT	0.47MF	20%	50V		
C1620	1-163-133-00	CERAMIC CHIP	470PF	5%	50V		
C1621	1-163-117-00	CERAMIC CHIP	100PF	5%	50V		
C1641	1-163-035-00	CERAMIC CHIP	0.047MF	5%	50V		
						<CONNECTOR>	
CN501	*1-564-506-11	PLUG, CONNECTOR 3P					
CN502	1-526-477-11	PIN, CONNECTOR 12P					
CN504	*1-564-507-11	PLUG, CONNECTOR 4P					
CN505	*1-564-509-11	PLUG, CONNECTOR 6P					
CN507	*1-564-507-11	PLUG, CONNECTOR 4P					
CN508	*1-564-104-00	PIN, CONNECTOR (B3P-VB) 3P					
CN509	*1-564-506-11	PLUG, CONNECTOR 3P					
						<DIODE>	
D501	8-719-404-46	DIODE M1110					
D502	8-719-404-46	DIODE M1110					
D503	8-719-404-46	DIODE M1110					
D504	8-719-404-46	DIODE M1110					
D506	8-719-908-03	DIODE GP08D					
D507	8-719-404-46	DIODE M1110					
D508	8-719-404-46	DIODE M1110					
D511	8-719-404-46	DIODE M1110					
D512	8-719-404-46	DIODE M1110					
D514	8-719-404-46	DIODE M1110					
D520	8-719-800-76	DIODE 1S5226					
D521	8-719-800-76	DIODE 1S5226					
D589	8-719-800-76	DIODE 1S5226					
D831	8-719-404-46	DIODE M1110					
D832	8-719-404-46	DIODE M1110					
D833	8-719-404-46	DIODE M1110					
D834	8-719-404-46	DIODE M1110					
D835	8-719-109-89	DIODE R05.6ES-B2					
D836	8-719-977-69	DIODE DT224B					
D848	8-719-800-76	DIODE 1S5226					
D1601	8-719-105-XX	DIODE R06.2M-B1					
D1603	8-719-977-61	DIODE DT220B					
D1606	8-719-981-00	DIODE E8C81-004					
D1607	8-719-981-00	DIODE E8C81-004					
D1608	8-719-977-02	DIODE DT25.6A					
D1609	8-719-977-49	DIODE DT215B					
D1610	8-719-404-46	DIODE M1110					
D1611	8-729-101-31	TRANSISTOR N13T1					
D1612	8-719-404-46	DIODE M1110					
D1615	8-719-404-46	DIODE M1110					
D1617	8-719-977-49	DIODE DT215B					
D1618	8-719-977-49	DIODE DT215B					
D1620	8-719-400-18	DIODE M11524K					
D1622	8-719-400-18	DIODE M11524K					
D1623	8-719-400-18	DIODE M11524K					
D1626	8-719-404-46	DIODE M1110					
D1627	8-719-404-46	DIODE M1110					
D1628	8-719-404-46	DIODE M1110					
D1635	8-719-404-46	DIODE M1110					
D1699	8-719-404-46	DIODE M1110					
						<FUSE>	
F1601	*1-533-177-21	FUSE, MICRO (SECONDARY)					
F1602	1-533-189-11	HOLDER, FUSE; F1601					
						<IC>	

D

REF. NO.	PART NO.	DESCRIPTION	REMARK	REF. NO.	PART NO.	DESCRIPTION	REMARK
IC501	8-759-909-70	IC CX23025		Q1616	8-729-216-22	TRANSISTOR 2SA1162-G	
IC502	8-759-100-60	IC WPC1377C		Q1617	8-729-216-22	TRANSISTOR 2SA1162-G	
IC503	8-759-801-98	IC LA7830		Q1618	8-729-216-22	TRANSISTOR 2SA1162-G	
IC504	8-759-701-79	IC MC7812CT					
IC505	8-759-009-51	IC MC145388F					
IC831	8-759-509-29	IC XR04011RF					
IC832	8-759-509-37	IC XR04070RF					
IC833	8-759-009-51	IC MC145388F					
IC1601	8-759-509-91	IC XRA10393F					
		<JUMPER RESISTOR>					
JR510	1-216-295-00	METAL GLAZE 0 5% 1/10W					
		<COIL>					
L501	1-410-093-11	INDUCTOR 33MMH					
L502	1-410-665-31	INDUCTOR 15UH					
L503	1-424-625-11	COIL, CHOKE (PMC) 3903H					
L506	1-412-530-31	INDUCTOR 27UH					
L1601	1-459-155-00	COIL (WITH CORE) 47UH					
L1602	1-402-785-11	COIL, CHOKE 600UH					
L1603	1-410-397-21	FERRITE BEAD INDUCTOR					
		<TRANSISTOR>					
Q501	8-729-901-01	TRANSISTOR DTC144EX					
Q502	8-729-901-01	TRANSISTOR DTC144EX					
Q503	8-729-901-06	TRANSISTOR DTA144EX					
Q504	8-729-901-01	TRANSISTOR DTC144EX					
Q505	8-729-422-27	TRANSISTOR 2SD601A-Q					
Q508	8-729-422-27	TRANSISTOR 2SD601A-Q					
Q509	8-729-422-27	TRANSISTOR 2SD601A-Q					
Q510	8-729-901-06	TRANSISTOR DTA144EX					
Q512	8-729-422-27	TRANSISTOR 2SD601A-Q					
Q513	8-729-216-22	TRANSISTOR 2SA1162-G					
Q515	8-729-313-42	TRANSISTOR 2SD1134-C					
Q518	8-729-422-27	TRANSISTOR 2SD601A-Q					
Q519	8-729-422-27	TRANSISTOR 2SD601A-Q					
Q532	8-729-422-27	TRANSISTOR 2SD601A-Q					
Q569	8-729-907-26	TRANSISTOR 1M1					
Q576	8-729-920-48	TRANSISTOR 1M2					
Q579	8-729-920-48	TRANSISTOR 1M2					
Q589	8-729-216-22	TRANSISTOR 2SA1162-G					
Q599	8-729-920-48	TRANSISTOR 1M2					
Q833	8-729-216-22	TRANSISTOR 2SA1162-G					
Q834	8-729-422-27	TRANSISTOR 2SD601A-Q					
Q835	8-729-422-27	TRANSISTOR 2SD601A-Q					
Q836	8-729-255-12	TRANSISTOR 2SC2551-D					
Q1601	8-729-422-27	TRANSISTOR 2SD601A-Q					
Q1602	8-729-422-27	TRANSISTOR 2SD601A-Q					
Q1603	8-729-422-27	TRANSISTOR 2SD601A-Q					
Q1604	8-729-216-22	TRANSISTOR 2SA1162-G					
Q1605	8-729-119-80	TRANSISTOR 2SC2688-L					
Q1606	8-729-133-42	TRANSISTOR 2SC2334-L					
Q1607	8-729-422-27	TRANSISTOR 2SD601A-Q					
Q1608	8-729-422-27	TRANSISTOR 2SD601A-Q					
Q1609	8-729-422-27	TRANSISTOR 2SD601A-Q					
Q1610	8-729-422-27	TRANSISTOR 2SD601A-Q					
Q1611	8-729-422-27	TRANSISTOR 2SD601A-Q					
Q1612	8-729-422-27	TRANSISTOR 2SD601A-Q					
Q1613	8-729-422-27	TRANSISTOR 2SD601A-Q					
Q1614	8-729-422-27	TRANSISTOR 2SD601A-Q					
Q1615	8-729-216-22	TRANSISTOR 2SA1162-G					
		<RESISTOR>					
R501	1-216-089-00	METAL GLAZE 47K 5% 1/10W					
R502	1-216-089-00	METAL GLAZE 47K 5% 1/10W					
R503	1-249-437-11	CARBON 47K 5% 1/4W F					
R504	1-216-073-00	METAL GLAZE 10K 5% 1/10W					
R505	1-249-393-11	CARBON 10 5% 1/4W F					
R506	1-216-071-00	METAL GLAZE 8.2K 5% 1/10W					
R507	1-216-059-00	METAL GLAZE 2.7K 5% 1/10W					
R508	1-216-085-00	METAL GLAZE 33K 5% 1/10W					
R509	1-216-687-11	METAL CHIP 33K 0.50% 1/10W					
R510	1-216-683-11	METAL CHIP 22K 0.50% 1/10W					
R511	1-216-675-11	METAL CHIP 10K 0.50% 1/10W					
R512	1-218-761-11	METAL CHIP 240K 0.50% 1/10W					
R513	1-216-065-00	METAL GLAZE 4.7K 5% 1/10W					
R514	1-218-754-11	METAL CHIP 120K 0.50% 1/10W					
R515	1-216-081-00	METAL GLAZE 22K 5% 1/10W					
R516	1-216-073-00	METAL GLAZE 10K 5% 1/10W					
R517	1-218-768-11	METAL CHIP 470K 0.50% 1/10W					
R518	1-249-422-11	CARBON 2.7K 5% 1/4W F					
R519	1-216-085-00	METAL GLAZE 33K 5% 1/10W					
R520	1-216-677-11	METAL CHIP 12K 0.50% 1/10W					
R521	1-216-067-00	METAL GLAZE 5.6K 5% 1/10W					
R522	1-216-107-00	METAL GLAZE 270K 5% 1/10W					
R523	1-216-081-00	METAL GLAZE 22K 5% 1/10W					
R524	1-216-049-00	METAL GLAZE 1K 5% 1/10W					
R525	1-216-434-11	METAL OXIDE 1.8K 5% 1W F					
R526	1-216-079-00	METAL GLAZE 18K 5% 1/10W					
R527	1-249-437-11	CARBON 47K 5% 1/4W F					
R528	1-216-073-00	METAL GLAZE 10K 5% 1/10W					
R529	1-216-073-00	METAL GLAZE 10K 5% 1/10W					
R530	1-216-089-00	METAL GLAZE 47K 5% 1/10W					
R531	1-216-089-00	METAL GLAZE 47K 5% 1/10W					
R532	1-216-097-00	METAL GLAZE 100K 5% 1/10W					
R533	1-216-089-00	METAL GLAZE 47K 5% 1/10W					
R534	1-216-097-00	METAL GLAZE 100K 5% 1/10W					
R535	1-216-093-00	METAL GLAZE 1.5K 5% 1/10W					
R536	1-212-881-11	FUSIBLE 100 5% 1/4W F					
R537	1-215-867-00	METAL OXIDE 470 5% 1W F					
R538	1-216-095-00	METAL GLAZE 82K 5% 1/10W					
R539	1-216-095-00	METAL GLAZE 82K 5% 1/10W					
R540	1-216-101-00	METAL GLAZE 150K 5% 1/10W					
R541	1-216-063-00	METAL GLAZE 3.9K 5% 1/10W					
R542	1-216-075-00	METAL GLAZE 12K 5% 1/10W					
R543	1-216-065-00	METAL GLAZE 4.7K 5% 1/10W					
R544	1-216-101-00	METAL GLAZE 150K 5% 1/10W					
R545	1-216-041-00	METAL GLAZE 470 5% 1/10W					
R546	1-216-091-00	METAL GLAZE 56K 5% 1/10W					
R547	1-216-121-00	METAL GLAZE 1M 5% 1/10W					
R548	1-216-107-00	METAL GLAZE 270K 5% 1/10W					
R549	1-216-101-00	METAL GLAZE 150K 5% 1/10W					
R550	1-216-354-11	METAL OXIDE 2.7 5% 1W F					
R552	1-216-061-00	METAL GLAZE 3.3K 5% 1/10W					
R553	1-216-091-00	METAL GLAZE 56K 5% 1/10W					
R554	1-216-073-00	METAL GLAZE 10K 5% 1/10W					
R555	1-216-077-00	METAL GLAZE 15K 5% 1/10W					
R557	1-216-057-00	METAL GLAZE 2.2K 5% 1/10W					
R558	1-216-049-00	METAL GLAZE 1K 5% 1/10W					
R559	1-216-065-00	METAL GLAZE 4.7K 5% 1/10W					

REF. NO.	PART NO.	DESCRIPTION	REMARK	REF. NO.	PART NO.	DESCRIPTION	REMARK
R560	1-216-037-00	METAL GLAZE	330 5%	1/10W	R1519	1-216-031-00	METAL GLAZE 180 5% 1/10W
R561	1-216-085-00	METAL GLAZE	35K	1/10W	R1520	1-216-057-00	METAL GLAZE 2.2K 5% 1/10W
R562	1-216-057-00	METAL GLAZE	2.2K 5%	1/10W	R1601	1-216-685-11	METAL CHIP 27K 0.50% 1/10W
R563	1-216-065-00	METAL GLAZE	4.7K 5%	1/10W	R1602	1-216-681-11	METAL CHIP 18K 0.50% 1/10W
R564	1-249-410-11	CARBON	270 5%	1/4W F	R1603	1-216-671-11	METAL CHIP 6.8K 0.50% 1/10W
R565	1-216-059-00	METAL GLAZE	2.7K 5%	1/10W	R1604	1-249-433-11	CARBON 22K 5% 1/4W F
R566	1-216-025-00	METAL GLAZE	100 5%	1/10W	R1605	1-216-070-00	METAL GLAZE 7.5K 5% 1/10W
R567	1-216-095-00	METAL GLAZE	82K 5%	1/10W	R1606	1-216-070-00	METAL GLAZE 7.5K 5% 1/10W
R568	1-216-063-00	METAL GLAZE	3.9K 5%	1/10W	R1607	1-216-071-00	METAL GLAZE 8.2K 5% 1/10W
R569	1-216-083-00	METAL GLAZE	3.9K 5%	1/10W	R1608	1-216-065-00	METAL GLAZE 4.7K 5% 1/10W
R570	1-216-093-00	METAL GLAZE	68K 5%	1/10W	R1609	1-216-069-00	METAL GLAZE 6.8K 5% 1/10W
R571	1-216-089-00	METAL GLAZE	47K 5%	1/10W	R1610	1-216-057-00	METAL GLAZE 2.2K 5% 1/10W
R572	1-216-095-00	METAL GLAZE	82K 5%	1/10W	R1611	1-216-057-00	METAL GLAZE 2.2K 5% 1/10W
R573	1-216-063-00	METAL GLAZE	3.9K 5%	1/10W	R1612	1-215-913-11	METAL OXIDE 220 5% 3W F
R574	1-216-063-00	METAL GLAZE	3.9K 5%	1/10W	R1613	1-216-025-00	METAL GLAZE 100 5% 1/10W
R575	1-216-105-00	METAL GLAZE	220K 5%	1/10W	R1614	1-216-667-00	METAL CHIP 5.6K 5% 1/10W
R576	1-216-109-00	METAL GLAZE	330K 5%	1/10W	R1615	1-216-657-11	METAL CHIP 1.8K 0.50% 1/10W
R577	1-216-105-00	METAL GLAZE	220K 5%	1/10W	R1616	1-216-629-11	METAL CHIP 120 0.50% 1/10W
R578	1-249-457-11	CARBON	6.8 5%	1/4W F	R1617	1-216-659-11	METAL CHIP 2.2K 0.50% 1/10W
R579	1-249-457-11	CARBON	6.8 5%	1/4W F	R1618	1-216-073-00	METAL GLAZE 10K 5% 1/10W
R580	1-216-001-00	METAL GLAZE	10 5%	1/10W	R1620	1-216-065-00	METAL GLAZE 4.7K 5% 1/10W
R590	1-216-105-00	METAL GLAZE	220K 5%	1/10W	R1621	1-216-073-00	METAL GLAZE 10K 5% 1/10W
R591	1-216-063-00	METAL GLAZE	3.9K 5%	1/10W	R1622	1-216-073-00	METAL GLAZE 10K 5% 1/10W
R592	1-216-033-00	METAL GLAZE	220 5%	1/10W	R1623	1-216-073-00	METAL GLAZE 10K 5% 1/10W
R831	1-216-049-00	METAL GLAZE	1K 5%	1/10W	R1624	1-216-246-00	METAL GLAZE 100K 5% 1/8W
R832	1-216-075-00	METAL GLAZE	12K 5%	1/10W	R1625	1-216-061-00	METAL GLAZE 3.3K 5% 1/10W
R833	1-216-065-00	METAL GLAZE	4.7K 5%	1/10W	R1626	1-216-065-00	METAL GLAZE 4.7K 5% 1/10W
R834	1-216-059-00	METAL GLAZE	2.7K 5%	1/10W	R1627	1-216-049-00	METAL GLAZE 18 5% 1/10W
R835	1-216-081-00	METAL GLAZE	22K 5%	1/10W	R1628	1-216-073-00	METAL GLAZE 10K 5% 1/10W
R836	1-216-049-00	METAL GLAZE	1K 5%	1/10W	R1629	1-216-683-11	METAL CHIP 22K 0.50% 1/10W
R837	1-216-075-00	METAL GLAZE	12K 5%	1/10W	R1630	1-216-683-11	METAL CHIP 22K 0.50% 1/10W
R838	1-216-049-00	METAL GLAZE	1K 5%	1/10W	R1631	1-216-057-00	METAL GLAZE 2.2K 5% 1/10W
R839	1-216-061-00	METAL GLAZE	3.3K 5%	1/10W	R1632	1-216-042-00	METAL GLAZE 510 5% 1/10W
R840	1-216-097-00	METAL GLAZE	100K 5%	1/10W	R1633	1-216-109-00	METAL GLAZE 330K 5% 1/10W
R841	1-216-093-00	METAL GLAZE	68K 5%	1/10W	R1634	1-216-039-00	METAL GLAZE 120K 5% 1/10W
R842	1-216-093-00	METAL GLAZE	68K 5%	1/10W	R1635	1-216-097-00	METAL GLAZE 100K 5% 1/10W
R843	1-216-065-00	METAL GLAZE	4.7K 5%	1/10W	R1636	1-216-073-00	METAL GLAZE 10K 5% 1/10W
R844	1-216-077-00	METAL GLAZE	15K 5%	1/10W	R1640	1-216-063-00	METAL GLAZE 3.9K 5% 1/10W
R847	1-216-049-00	METAL GLAZE	1K 5%	1/10W	R1641	1-216-073-00	METAL GLAZE 10K 5% 1/10W
R850	1-216-085-00	METAL GLAZE	33K 5%	1/10W	R1642	1-216-073-00	METAL GLAZE 10K 5% 1/10W
R851	1-216-669-11	METAL CHIP	5.6K 0.50%	1/10W	R1643	1-216-069-00	METAL GLAZE 6.8K 5% 1/10W
R852	1-216-675-11	METAL CHIP	10K 0.50%	1/10W	R1644	1-216-069-00	METAL GLAZE 6.8K 5% 1/10W
R853	1-216-105-00	METAL GLAZE	220K 5%	1/10W	R1645	1-216-073-00	METAL GLAZE 10K 5% 1/10W
R854	1-218-754-11	METAL CHIP	120K 0.50%	1/10W	R1646	1-216-073-00	METAL GLAZE 10K 5% 1/10W
R855	1-216-697-11	METAL CHIP	82K 0.50%	1/10W	R1647	1-216-685-11	METAL CHIP 27K 0.50% 1/10W
R856	1-218-755-11	METAL CHIP	130K 0.50%	1/10W	R1648	1-216-069-00	METAL GLAZE 6.8K 5% 1/10W
R857	1-216-686-11	METAL CHIP	30K 0.50%	1/10W	R1649	1-216-069-00	METAL GLAZE 6.8K 5% 1/10W
R858	1-216-061-00	METAL GLAZE	3.3K 5%	1/10W	R1650	1-216-069-00	METAL GLAZE 6.8K 5% 1/10W
R859	1-216-436-00	METAL OXIDE	3.9K 5%	1W F	R1651	1-216-069-00	METAL GLAZE 6.8K 5% 1/10W
R860	1-216-679-11	METAL CHIP	15K 0.50%	1/10W	R1652	1-216-069-00	METAL GLAZE 6.8K 5% 1/10W
R861	1-216-672-11	METAL CHIP	7.5K 0.50%	1/10W	R1653	1-216-069-00	METAL GLAZE 6.8K 5% 1/10W
R862	1-216-675-11	METAL CHIP	10K 0.50%	1/10W	R1654	1-216-681-11	METAL CHIP 18K 0.50% 1/10W
R863	1-249-435-11	CARBON	33K 5%	1/4W F	R1655	1-216-081-00	METAL GLAZE 22K 5% 1/10W
R1503	1-216-049-00	METAL GLAZE	1K 5%	1/10W	R1656	1-216-643-11	METAL CHIP 470 0.50% 1/10W
R1504	1-216-689-11	METAL CHIP	39K 0.50%	1/10W	R1657	1-216-081-00	METAL GLAZE 22K 5% 1/10W
R1505	1-216-089-00	METAL GLAZE	47K 5%	1/10W	R1658	1-216-065-00	METAL GLAZE 3.9K 5% 1/10W
R1506	1-216-667-11	METAL CHIP	4.7K 0.50%	1/10W	R1659	1-216-049-00	METAL GLAZE 1K 5% 1/10W
R1507	1-216-081-00	METAL GLAZE	22K 5%	1/10W	R1660	1-216-649-11	METAL CHIP 820 0.50% 1/10W
R1508	1-216-073-00	METAL GLAZE	10K 5%	1/10W	R1661	1-216-065-00	METAL GLAZE 4.7K 5% 1/10W
R1509	1-216-065-00	METAL GLAZE	4.7K 5%	1/10W			
R1510	1-249-425-11	CARBON	4.7K 5%	1/4W F			
R1511	1-216-033-00	METAL GLAZE	220 5%	1/10W			
R1512	1-216-049-00	METAL GLAZE	1K 5%	1/10W			
R1513	1-216-017-00	METAL GLAZE	47 5%	1/10W			
						<VARIABLE RESISTOR>	
					RV501	1-238-019-11	RES. ADJ. CARBON 47K

